

Notice for TAIYO YUDEN products

Please read this notice before using the TAIYO YUDEN products.

REMINDERS

- Product information in this catalog is as of October 2014. All of the contents specified herein are subject to change without notice due to technical improvements, etc. Therefore, please check for the latest information carefully before practical application or usage of the Products.

Please note that TAIYO YUDEN CO., LTD. shall not be responsible for any defects in products or equipment incorporating such products, which are caused under the conditions other than those specified in this catalog or individual specification.

- Please contact TAIYO YUDEN CO., LTD. for further details of product specifications as the individual specification is available.

- Please conduct validation and verification of products in actual condition of mounting and operating environment before commercial shipment of the equipment.

- All electronic components or functional modules listed in this catalog are developed, designed and intended for use in general electronics equipment.(for AV, office automation, household, office supply, information service, telecommunications, (such as mobile phone or PC) etc.). Before incorporating the components or devices into any equipment in the field such as transportation,(automotive control, train control, ship control), transportation signal, disaster prevention, medical, public information network (telephone exchange, base station) etc. which may have direct influence to harm or injure a human body, please contact TAIYO YUDEN CO., LTD. for more detail in advance.

Do not incorporate the products into any equipment in fields such as aerospace, aviation, nuclear control, submarine system, military, etc. where higher safety and reliability are especially required.

In addition, even electronic components or functional modules that are used for the general electronic equipment, if the equipment or the electric circuit require high safety or reliability function or performances, a sufficient reliability evaluation check for safety shall be performed before commercial shipment and moreover, due consideration to install a protective circuit is strongly recommended at customer's design stage.

- The contents of this catalog are applicable to the products which are purchased from our sales offices or distributors (so called "TAIYO YUDEN' s official sales channel").

It is only applicable to the products purchased from any of TAIYO YUDEN' s official sales channel.

- Please note that TAIYO YUDEN CO., LTD. shall have no responsibility for any controversies or disputes that may occur in connection with a third party's intellectual property rights and other related rights arising from your usage of products in this catalog. TAIYO YUDEN CO., LTD. grants no license for such rights.

- Caution for export

Certain items in this catalog may require specific procedures for export according to "Foreign Exchange and Foreign Trade Control Law" of Japan, "U.S. Export Administration Regulations", and other applicable regulations. Should you have any question or inquiry on this matter, please contact our sales staff.

MULTILAYER CERAMIC CAPACITORS

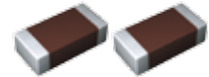

WAVE

REFLOW

PARTS NUMBER

| | | | | | | | | | | | | | | | | |
|---|---|---|---|---|---|---|---|---|---|---|---|---|---|---|---|---|
| J | M | K | 3 | 1 | 6 | △ | B | J | 1 | 0 | 6 | M | L | - | T | △ |
| ① | ② | ③ | ④ | ⑤ | ⑥ | ⑦ | ⑧ | ⑨ | ⑩ | ⑪ | ⑫ | | | | | |

△=Blank space

① Rated voltage

| Code | Rated voltage [VDC] |
|------|---------------------|
| P | 2.5 |
| A | 4 |
| J | 6.3 |
| L | 10 |
| E | 16 |
| T | 25 |
| G | 35 |
| U | 50 |
| H | 100 |
| Q | 250 |
| S | 630 |

③ End termination

| Code | End termination |
|------|------------------------|
| K | Plated |
| S | Cu Internal Electrodes |

② Series name

| Code | Series name |
|------|---|
| M | Multilayer ceramic capacitor |
| V | Multilayer ceramic capacitor for high frequency |
| W | LW reverse type multilayer capacitor |

④ Dimension (L × W)

| Type | Dimensions (L × W) [mm] | EIA (inch) |
|------|-------------------------|------------|
| 042 | 0.4 × 0.2 | 01005 |
| 063 | 0.6 × 0.3 | 0201 |
| 105 | 1.0 × 0.5 | 0402 |
| | 0.52 × 1.0 ※ | 0204 |
| 107 | 1.6 × 0.8 | 0603 |
| | 0.8 × 1.6 ※ | 0306 |
| 212 | 2.0 × 1.25 | 0805 |
| | 1.25 × 2.0 ※ | 0508 |
| 316 | 3.2 × 1.6 | 1206 |
| 325 | 3.2 × 2.5 | 1210 |
| 432 | 4.5 × 3.2 | 1812 |

Note : ※LW reverse type (□WK) only

⑤ Dimension tolerance

| Code | Type | L [mm] | W [mm] | T [mm] |
|-----------|----------|----------------|-----------------|-----------------|
| △ | ALL | Standard | Standard | Standard |
| A | 063 | 0.6±0.05 | 0.3±0.05 | 0.3±0.05 |
| | 105 | 1.0±0.10 | 0.5±0.10 | 0.5±0.10 |
| | 107 | 1.6+0.15/-0.05 | 0.8+0.15/-0.05 | 0.8+0.15/-0.05 |
| | 212 | 2.0+0.15/-0.05 | 1.25+0.15/-0.05 | 0.45±0.05 |
| | | | | 0.85±0.10 |
| | | | | 1.25+0.15/-0.05 |
| 316 | 3.2±0.20 | 1.6±0.20 | 0.85±0.10 | |
| 325 | 3.2±0.30 | 2.5±0.30 | 1.6±0.20 | |
| B | 063 | 0.6±0.09 | 0.3±0.09 | 0.3±0.09 |
| | 105 | 1.0+0.15/-0.05 | 0.5+0.15/-0.05 | 0.5+0.15/-0.05 |
| | 107 | 1.6+0.20/-0 | 0.8+0.20/-0 | 0.45±0.05 |
| | | | | 0.8+0.20/-0 |
| | 212 | 2.0+0.20/-0 | 1.25+0.20/-0 | 0.45±0.05 |
| 0.85±0.10 | | | | |
| 316 | 3.2±0.30 | 1.6±0.30 | 1.25+0.20/-0 | |
| C | 105 | 1.0+0.20/-0 | 0.5+0.20/-0 | 1.6±0.30 |
| | | | | 0.5+0.20/-0 |

Note: P.6 Standard external dimensions

△= Blank space

⑥ Temperature characteristics code

■ High dielectric type (Excluding Super low distortion multilayer ceramic capacitor (CFCAP™))

| Code | Applicable standard | Temperature range [°C] | Ref. Temp. [°C] | Capacitance change | Capacitance tolerance | Tolerance code |
|-------|---------------------|------------------------|-----------------|--------------------|-----------------------|----------------|
| BJ | JIS B | -25~+85 | 20 | ±10% | ±10% | K |
| | EIA X5R | -55~+85 | 25 | | ±20% | M |
| B7 | EIA X7R | -55~+125 | 25 | ±15% | ±10% | K |
| | | | | | ±20% | M |
| C6 | EIA X6S | -55~+105 | 25 | ±22% | ±10% | K |
| | | | | | ±20% | M |
| C7 | EIA X7S | -55~+125 | 25 | ±22% | ±10% | K |
| | | | | | ±20% | M |
| LD(※) | EIA X5R | -55~+85 | 25 | ±15% | ±10% | K |
| | | | | | ±20% | M |
| △F | JIS F | -25~+85 | 20 | +30/-80% | +80/-20% | Z |
| | EIA Y5V | -30~+85 | 25 | | | |

Note : ※LD Low distortion high value multilayer ceramic capacitor

△= Blank space

▶ This catalog contains the typical specification only due to the limitation of space. When you consider the purchase of our products, please check our specification. For details of each product (characteristics graph, reliability information, precautions for use, and so on), see our Web site (<http://www.ty-top.com/>).

■Temperature compensating type

| Code | Applicable standard | | Temperature range [°C] | Ref. Temp. [°C] | Capacitance change | Capacitance tolerance | Tolerance code | |
|------|---------------------|-----|------------------------|-----------------|--------------------|-----------------------|----------------|---|
| CG | EIA | C0G | -55~+125 | 25 | 0±30ppm/°C | ±0.1pF | B | |
| | | | | | | ±0.25pF | C | |
| | | | | | | ±0.5pF | D | |
| | | | | | | ±1pF | F | |
| | | | | | | ±5% | J | |
| CH | JIS | CH | -55~+125 | 20 | 0±60ppm/°C | ±0.1pF | B | |
| | | | | | | ±0.25pF | C | |
| | | | | | | ±0.5pF | D | |
| | EIA | C0H | | 25 | | 0±60ppm/°C | ±1pF | F |
| | | | | | | | ±5% | J |
| | | | | | | | ±10% | K |
| CJ | JIS | CJ | -55~+125 | 20 | 0±120ppm/°C | ±0.25pF | C | |
| | EIA | C0J | | 25 | | | | |
| CK | JIS | CK | -55~+125 | 20 | 0±250ppm/°C | ±0.25pF | C | |
| | EIA | C0J | | 25 | | | | |
| UJ | JIS | UJ | -55~+125 | 20 | -750±120ppm/°C | ±0.25pF | C | |
| | EIA | U2J | | 25 | | ±5% | J | |
| UK | JIS | UK | -55~+125 | 20 | -750±250ppm/°C | ±0.5pF | C | |
| | EIA | U2K | -55~+125 | 25 | | | | |
| SL | JIS | SL | -55~+125 | 20 | +350~-1000ppm/°C | ±5% | J | |

⑥Series code

(Super low distortion multilayer ceramic capacitor(CFCAP™) only)

| Code | Series code |
|------|-------------|
| SD | Standard |

•Medium-High Voltage Multilayer Ceramic Capacitors

| Code | Series code |
|------|-------------|
| SD | Standard |

⑦Nominal capacitance

| Code (example) | Nominal capacitance |
|----------------|---------------------|
| 0R5 | 0.5pF |
| 010 | 1pF |
| 100 | 10pF |
| 101 | 100pF |
| 102 | 1,000pF |
| 103 | 10,000pF |
| 104 | 0.1 μF |
| 105 | 1.0 μF |
| 106 | 10 μF |
| 107 | 100 μF |

Note : R=Decimal point

⑧Capacitance tolerance

| Code | Capacitance tolerance |
|------|-----------------------|
| B | ±0.1pF |
| C | ±0.25pF |
| D | ±0.5pF |
| F | ±1pF |
| G | ±2% |
| J | ±5% |
| K | ±10% |
| M | ±20% |
| Z | +80/-20% |

⑨Thickness

| Code | Thickness [mm] |
|------|-----------------------|
| C | 0.2 |
| D | |
| P | |
| T | 0.3 |
| K | |
| V | 0.45 |
| W | |
| A | 0.8 |
| D | 0.85(212type or more) |
| F | 1.15 |
| G | 1.25 |
| L | 1.6 |
| N | 1.9 |
| Y | 2.0 max |
| M | 2.5 |

⑩Special code

| Code | Special code |
|------|--------------|
| - | Standard |

⑪Packaging

| Code | Packaging |
|------|--|
| F | φ 178mm Taping (2mm pitch) |
| T | φ 178mm Taping (4mm pitch) |
| P | φ 178mm Taping (4mm pitch, 1000 pcs/reel) 325 type (Thickness code M) |
| W | φ 178mm Taping (1mm pitch) 042type only |

⑫Internal code

| Code | Internal code |
|------|---------------|
| Δ | Standard |

► This catalog contains the typical specification only due to the limitation of space. When you consider the purchase of our products, please check our specification. For details of each product (characteristics graph, reliability information, precautions for use, and so on), see our Web site (<http://www.ty-top.com/>).

■ STANDARD EXTERNAL DIMENSIONS

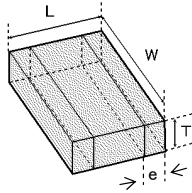
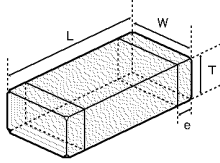

※ LW reverse type

| Type(EIA) | Dimension [mm] | | | | |
|---------------|----------------|-----------|--------------|----|----------------|
| | L | W | T | *1 | e |
| □MK042(01005) | 0.4±0.02 | 0.2±0.02 | 0.2±0.02 | C | 0.1±0.03 |
| □VS042(01005) | 0.4±0.02 | 0.2±0.02 | 0.2±0.02 | D | |
| □MK063(0201) | 0.6±0.03 | 0.3±0.03 | 0.3±0.03 | C | 0.15±0.05 |
| | | | | T | |
| □MK105(0402) | 1.0±0.05 | 0.5±0.05 | 0.2±0.02 | C | 0.25±0.10 |
| | | | 0.3±0.03 | P | |
| | | | 0.5±0.05 | V | |
| □VK105(0402) | 1.0±0.05 | 0.5±0.05 | 0.5±0.05 | W | 0.25±0.10 |
| □WK105(0204)※ | 0.52±0.05 | 1.0±0.05 | 0.3±0.05 | P | 0.18±0.08 |
| □MK107(0603) | 1.6±0.10 | 0.8±0.10 | 0.45±0.05 | K | 0.35±0.25 |
| | | | 0.8±0.10 | A | |
| □WK107(0306)※ | 0.8±0.10 | 1.6±0.10 | 0.5±0.05 | V | 0.25±0.15 |
| □MK212(0805) | 2.0±0.10 | 1.25±0.10 | 0.45±0.05 | K | 0.5±0.25 |
| | | | 0.85±0.10 | D | |
| | | | 1.25±0.10 | G | |
| □WK212(0508)※ | 1.25±0.15 | 2.0±0.15 | 0.85±0.1 | D | 0.3±0.2 |
| □MK316(1206) | 3.2±0.15 | 1.6±0.15 | 0.85±0.10 | D | 0.5+0.35/-0.25 |
| | | | 1.15±0.10 | F | |
| | | | 1.25±0.10 | G | |
| | | | 1.6±0.20 | L | |
| □MK325(1210) | 3.2±0.30 | 2.5±0.20 | 0.85±0.10 | D | 0.6±0.3 |
| | | | 1.15±0.10 | F | |
| | | | 1.9±0.20 | N | |
| | | | 1.9+0.1/-0.2 | Y | |
| □MK432(1812) | 4.5±0.40 | 3.2±0.30 | 2.5±0.20 | M | 0.9±0.6 |

Note : ※. LW reverse type, *1.Thickness code

■ STANDARD QUANTITY

| Type | EIA (inch) | Dimension | | Standard quantity [pcs] | |
|---------|------------|-----------|------|-------------------------|-----------------|
| | | [mm] | Code | Paper tape | Embossed tape |
| 042 | 01005 | 0.2 | C | — | 40000 |
| | | | D | | |
| 063 | 0201 | 0.3 | P | 15000 | — |
| | | | T | | |
| 105 | 0402 | 0.2 | C | 20000 | — |
| | | 0.3 | P | 15000 | — |
| | | 0.5 | V | 10000 | — |
| | | | W | | |
| 0204 ※ | 0.30 | P | — | — | |
| 107 | 0603 | 0.45 | K | 4000 | — |
| | | 0.8 | A | — | — |
| | 0306 ※ | 0.50 | V | — | 4000 |
| 212 | 0805 | 0.45 | K | 4000 | — |
| | | 0.85 | D | — | 3000 |
| | | 1.25 | G | — | — |
| 0508 ※ | 0.85 | D | 4000 | — | |
| 316 | 1206 | 0.85 | D | 4000 | — |
| | | 1.15 | F | — | 3000 |
| | | 1.25 | G | — | — |
| 325 | 1210 | 1.6 | L | — | 2000 |
| | | 0.85 | D | — | 2000 |
| | | 1.15 | F | | |
| | | 1.9 | N | | |
| 2.0 max | Y | | | | |
| 432 | 1812 | 2.5 | M | — | 500(T), 1000(P) |
| | | | | — | 500 |

Note : ※.LW Reverse type(□WK)

▶ This catalog contains the typical specification only due to the limitation of space. When you consider the purchase of our products, please check our specification. For details of each product (characteristics graph, reliability information, precautions for use, and so on), see our Web site (<http://www.ty-top.com/>).

• All the Multilayer Ceramic Capacitors of Catalog Lineup are Compliance RoHS.
 • Capacitance tolerance code is applied to □ of part number.

Note)
 *1 We may provide X7R/X7S for some items according to the individual specification.
 *2 The exchange of individual specification is necessary depending on the application and circuit condition. Please contact TAIYO YUDEN sales channels.
 *3 The size standard should look at ④Dimension, ⑤Dimension tolerance, and ⑨Thickness, and P.6 Standard external dimensions.

Multilayer Ceramic Capacitors (High dielectric type)

●042TYPE

[Temperature Characteristic BJ : B/X5R] 0.2mm thickness(G)

| Part number 1 | Part number 2 | Rated voltage [V] | Temperature characteristics | | Capacitance [F] | Capacitance tolerance [%] | tan δ [%] | HTLT | Thickness* ³ [mm] | Soldering R:Reflow W:Wave | |
|------------------|---------------|-------------------|-----------------------------|-------------------|-------------------|---------------------------|-----------|-------------------|------------------------------|---------------------------|---|
| | | | | | | | | Rated voltage x % | | | |
| LMK042 BJ101□C-W | | 10 | B | X5R ^{*1} | 100 p | ±10, ±20 | 5 | 200 | 0.2±0.02 | R | |
| LMK042 BJ151□C-W | | | B | X5R ^{*1} | 150 p | ±10, ±20 | 5 | 200 | 0.2±0.02 | R | |
| LMK042 BJ221□C-W | | | B | X5R ^{*1} | 220 p | ±10, ±20 | 5 | 200 | 0.2±0.02 | R | |
| LMK042 BJ331□C-W | | | B | X5R ^{*1} | 330 p | ±10, ±20 | 5 | 200 | 0.2±0.02 | R | |
| LMK042 BJ471□C-W | | | B | X5R ^{*1} | 470 p | ±10, ±20 | 5 | 200 | 0.2±0.02 | R | |
| LMK042 BJ681□C-W | | | B | X5R ^{*1} | 680 p | ±10, ±20 | 5 | 200 | 0.2±0.02 | R | |
| LMK042 BJ102□C-W | | | B | X5R ^{*1} | 1000 p | ±10, ±20 | 5 | 200 | 0.2±0.02 | R | |
| LMK042 BJ152□C-W | | | X5R | | 1500 p | ±10, ±20 | 10 | 150 | 0.2±0.02 | R | |
| LMK042 BJ222□C-W | | | X5R | | 2200 p | ±10, ±20 | 10 | 150 | 0.2±0.02 | R | |
| LMK042 BJ332□C-W | | | X5R | | 3300 p | ±10, ±20 | 10 | 150 | 0.2±0.02 | R | |
| LMK042 BJ472□C-W | | | X5R | | 4700 p | ±10, ±20 | 10 | 150 | 0.2±0.02 | R | |
| LMK042 BJ682□C-W | | | X5R | | 6800 p | ±10, ±20 | 10 | 150 | 0.2±0.02 | R | |
| LMK042 BJ103□C-W | | | X5R | | 10000 p | ±10, ±20 | 10 | 150 | 0.2±0.02 | R | |
| JMK042 BJ152□C-W | | | 6.3 | B | X5R ^{*1} | 1500 p | ±10, ±20 | 10 | 150 | 0.2±0.02 | R |
| JMK042 BJ222□C-W | | | | B | X5R ^{*1} | 2200 p | ±10, ±20 | 10 | 150 | 0.2±0.02 | R |
| JMK042 BJ332□C-W | | | | B | X5R ^{*1} | 3300 p | ±10, ±20 | 10 | 150 | 0.2±0.02 | R |
| JMK042 BJ472□C-W | | B | | X5R ^{*1} | 4700 p | ±10, ±20 | 10 | 150 | 0.2±0.02 | R | |
| JMK042 BJ682□C-W | | B | | X5R ^{*1} | 6800 p | ±10, ±20 | 10 | 150 | 0.2±0.02 | R | |
| JMK042 BJ103□C-W | | B | | X5R ^{*1} | 10000 p | ±10, ±20 | 10 | 150 | 0.2±0.02 | R | |
| JMK042 BJ223□C-W | | X5R | | | 22000 p | ±10, ±20 | 10 | 150 | 0.2±0.02 | R | |
| JMK042 BJ473□C-W | | X5R | | | 47000 p | ±10, ±20 | 10 | 150 | 0.2±0.02 | R | |
| JMK042 BJ104□C-W | | X5R | | | 0.1 μ | ±10, ±20 | 10 | 150 | 0.2±0.02 | R | |
| AMK042 BJ473□C-W | | 4 | | X5R | | 47000 p | ±10, ±20 | 10 | 150 | 0.2±0.02 | R |
| AMK042 BJ104□C-W | | | X5R | | 0.1 μ | ±10, ±20 | 10 | 150 | 0.2±0.02 | R | |

[Temperature Characteristic B7 : X7R] 0.2mm thickness(C)

| Part number 1 | Part number 2 | Rated voltage [V] | Temperature characteristics | | Capacitance [F] | Capacitance tolerance [%] | tan δ [%] | HTLT | Thickness* ³ [mm] | Soldering R:Reflow W:Wave | |
|------------------|---------------|-------------------|-----------------------------|-----|-----------------|---------------------------|-----------|-------------------|------------------------------|---------------------------|---|
| | | | | | | | | Rated voltage x % | | | |
| EMK042 B7101□C-W | | 16 | X7R | | 100 p | ±10, ±20 | 5 | 200 | 0.2±0.02 | R | |
| EMK042 B7151□C-W | | | X7R | | 150 p | ±10, ±20 | 5 | 200 | 0.2±0.02 | R | |
| EMK042 B7221□C-W | | | X7R | | 220 p | ±10, ±20 | 5 | 200 | 0.2±0.02 | R | |
| EMK042 B7331□C-W | | | X7R | | 330 p | ±10, ±20 | 5 | 200 | 0.2±0.02 | R | |
| EMK042 B7471□C-W | | | X7R | | 470 p | ±10, ±20 | 5 | 200 | 0.2±0.02 | R | |
| EMK042 B7681□C-W | | | X7R | | 680 p | ±10, ±20 | 5 | 200 | 0.2±0.02 | R | |
| EMK042 B7102□C-W | | | X7R | | 1000 p | ±10, ±20 | 5 | 200 | 0.2±0.02 | R | |
| LMK042 B7101□C-W | | | 10 | X7R | | 100 p | ±10, ±20 | 5 | 200 | 0.2±0.02 | R |
| LMK042 B7151□C-W | | | | X7R | | 150 p | ±10, ±20 | 5 | 200 | 0.2±0.02 | R |
| LMK042 B7221□C-W | | | | X7R | | 220 p | ±10, ±20 | 5 | 200 | 0.2±0.02 | R |
| LMK042 B7331□C-W | | X7R | | | 330 p | ±10, ±20 | 5 | 200 | 0.2±0.02 | R | |
| LMK042 B7471□C-W | | X7R | | | 470 p | ±10, ±20 | 5 | 200 | 0.2±0.02 | R | |
| LMK042 B7681□C-W | | X7R | | | 680 p | ±10, ±20 | 5 | 200 | 0.2±0.02 | R | |
| LMK042 B7102□C-W | | X7R | | | 1000 p | ±10, ±20 | 5 | 200 | 0.2±0.02 | R | |

●063TYPE

[Temperature Characteristic BJ : B/X5R] 0.3mm thickness(P)

| Part number 1 | Part number 2 | Rated voltage [V] | Temperature characteristics | | Capacitance [F] | Capacitance tolerance [%] | tan δ [%] | HTLT | Thickness* ³ [mm] | Soldering R:Reflow W:Wave | |
|------------------|---------------|-------------------|-----------------------------|-------------------|-----------------|---------------------------|-----------|-------------------|------------------------------|---------------------------|---|
| | | | | | | | | Rated voltage x % | | | |
| UMK063 BJ101□P-F | | 50 | B | X5R ^{*1} | 100 p | ±10, ±20 | 3.5 | 200 | 0.3±0.03 | R | |
| UMK063 BJ151□P-F | | | B | X5R ^{*1} | 150 p | ±10, ±20 | 3.5 | 200 | 0.3±0.03 | R | |
| UMK063 BJ221□P-F | | | B | X5R ^{*1} | 220 p | ±10, ±20 | 3.5 | 200 | 0.3±0.03 | R | |
| UMK063 BJ331□P-F | | | B | X5R ^{*1} | 330 p | ±10, ±20 | 3.5 | 200 | 0.3±0.03 | R | |
| UMK063 BJ471□P-F | | | B | X5R ^{*1} | 470 p | ±10, ±20 | 3.5 | 200 | 0.3±0.03 | R | |
| UMK063 BJ681□P-F | | | B | X5R ^{*1} | 680 p | ±10, ±20 | 3.5 | 200 | 0.3±0.03 | R | |
| UMK063 BJ102□P-F | | | B | X5R ^{*1} | 1000 p | ±10, ±20 | 3.5 | 200 | 0.3±0.03 | R | |
| UMK063 BJ152□P-F | | | B | X5R | 1500 p | ±10, ±20 | 5 | 200 | 0.3±0.03 | R | |
| UMK063 BJ222□P-F | | | B | X5R | 2200 p | ±10, ±20 | 5 | 200 | 0.3±0.03 | R | |
| UMK063 BJ332□P-F | | | B | X5R | 3300 p | ±10, ±20 | 5 | 200 | 0.3±0.03 | R | |
| UMK063 BJ472□P-F | | | B | X5R | 4700 p | ±10, ±20 | 5 | 200 | 0.3±0.03 | R | |
| UMK063 BJ682□P-F | | | B | X5R | 6800 p | ±10, ±20 | 5 | 200 | 0.3±0.03 | R | |
| UMK063 BJ103□P-F | | | B | X5R | 10000 p | ±10, ±20 | 5 | 200 | 0.3±0.03 | R | |
| UMK063 BJ103□P-F | | | 35 | X5R | | 10000 p | ±10, ±20 | 5 | 200 | 0.3±0.03 | R |
| GMK063 BJ104□P-F | | | | X5R | | 0.1 μ | ±10, ±20 | 10 | 150 | 0.3±0.03 | R |
| TMK063 BJ152□P-F | | | | B | X5R | 1500 p | ±10, ±20 | 5 | 200 | 0.3±0.03 | R |
| TMK063 BJ222□P-F | | B | | X5R | 2200 p | ±10, ±20 | 5 | 200 | 0.3±0.03 | R | |
| TMK063 BJ332□P-F | | B | | X5R | 3300 p | ±10, ±20 | 5 | 200 | 0.3±0.03 | R | |
| TMK063 BJ472□P-F | | B | | X5R | 4700 p | ±10, ±20 | 5 | 200 | 0.3±0.03 | R | |
| TMK063 BJ682□P-F | | B | | X5R | 6800 p | ±10, ±20 | 5 | 200 | 0.3±0.03 | R | |
| TMK063 BJ103□P-F | | B | | X5R | 10000 p | ±10, ±20 | 5 | 200 | 0.3±0.03 | R | |
| TMK063 BJ223□P-F | | B | | X5R | 22000 p | ±10, ±20 | 7.5 | 150 | 0.3±0.03 | R | |
| TMK063ABJ104□P-F | | X5R | | | 0.1 μ | ±10, ±20 | 10 | 150 | 0.3±0.05 | R | |
| EMK063 BJ152□P-F | | 25 | B | X5R ^{*1} | 1500 p | ±10, ±20 | 5 | 200 | 0.3±0.03 | R | |
| EMK063 BJ222□P-F | | | B | X5R ^{*1} | 2200 p | ±10, ±20 | 5 | 200 | 0.3±0.03 | R | |
| EMK063 BJ332□P-F | | | B | X5R ^{*1} | 3300 p | ±10, ±20 | 5 | 200 | 0.3±0.03 | R | |
| EMK063 BJ472□P-F | | | B | X5R ^{*1} | 4700 p | ±10, ±20 | 5 | 200 | 0.3±0.03 | R | |
| EMK063 BJ682□P-F | | | B | X5R ^{*1} | 6800 p | ±10, ±20 | 5 | 200 | 0.3±0.03 | R | |
| EMK063 BJ103□P-F | | | B | X5R ^{*1} | 10000 p | ±10, ±20 | 5 | 200 | 0.3±0.03 | R | |
| EMK063 BJ223□P-F | | | B | X5R | 22000 p | ±10, ±20 | 7.5 | 150 | 0.3±0.03 | R | |
| EMK063 BJ333□P-F | | | X5R | | 33000 p | ±10, ±20 | 7.5 | 150 | 0.3±0.03 | R | |
| EMK063 BJ473□P-F | | | X5R | | 47000 p | ±10, ±20 | 7.5 | 150 | 0.3±0.03 | R | |

▶ This catalog contains the typical specification only due to the limitation of space. When you consider the purchase of our products, please check our specification. For details of each product (characteristics graph, reliability information, precautions for use, and so on), see our Web site (<http://www.ty-top.com/>).

■ PARTS NUMBER

| Part number 1 | Part number 2 | Rated voltage [V] | Temperature characteristics | | Capacitance [F] | Capacitance tolerance [%] | tan δ [%] | HTLT | Thickness ³ [mm] | Soldering R:Reflow W:Wave |
|-------------------|---------------|-------------------|-----------------------------|---------|-----------------|---------------------------|-----------|-------------------|-----------------------------|---------------------------|
| | | | | | | | | Rated voltage x % | | |
| EMK063 BJ683[P-F] | | 16 | | X5R | 68000 p | ±10, ±20 | 10 | 150 | 0.3±0.03 | R |
| EMK063 BJ104[P-F] | | | X5R | 0.1 μ | ±10, ±20 | 10 | 150 | 0.3±0.03 | R | |
| EMK063 BJ224[P-F] | | | X5R | 0.22 μ | ±10, ±20 | 10 | 150 | 0.3±0.03 | R | |
| LMK063 BJ223[P-F] | | 10 | B | X5R | 22000 p | ±10, ±20 | 7.5 | 150 | 0.3±0.03 | R |
| LMK063 BJ333[P-F] | | | X5R | 33000 p | ±10, ±20 | 7.5 | 150 | 0.3±0.03 | R | |
| LMK063 BJ473[P-F] | | | X5R | 47000 p | ±10, ±20 | 7.5 | 150 | 0.3±0.03 | R | |
| LMK063 BJ683[P-F] | | | X5R | 68000 p | ±10, ±20 | 10 | 150 | 0.3±0.03 | R | |
| LMK063 BJ104[P-F] | | | X5R | 0.1 μ | ±10, ±20 | 10 | 150 | 0.3±0.03 | R | |
| LMK063 BJ224[P-F] | | | X5R | 0.22 μ | ±10, ±20 | 10 | 150 | 0.3±0.03 | R | |
| LMK063BBJ105MPLF | | | X5R | 1 μ | ±20 | 10 | 150 | 0.3±0.09 | R | |
| JMK063 BJ223[P-F] | | 6.3 | B | X5R | 22000 p | ±10, ±20 | 7.5 | 150 | 0.3±0.03 | R |
| JMK063 BJ333[P-F] | | | X5R | 33000 p | ±10, ±20 | 7.5 | 150 | 0.3±0.03 | R | |
| JMK063 BJ473[P-F] | | | X5R | 47000 p | ±10, ±20 | 7.5 | 150 | 0.3±0.03 | R | |
| JMK063 BJ683[P-F] | | | X5R | 68000 p | ±10, ±20 | 10 | 150 | 0.3±0.03 | R | |
| JMK063 BJ104[P-F] | | | X5R | 0.1 μ | ±10, ±20 | 10 | 150 | 0.3±0.03 | R | |
| JMK063 BJ224[P-F] | | | X5R | 0.22 μ | ±10, ±20 | 10 | 150 | 0.3±0.03 | R | |
| JMK063 BJ334MP-F | | | X5R | 0.33 μ | ±20 | 10 | 150 | 0.3±0.03 | R | |
| JMK063 BJ474[P-F] | | | X5R | 0.47 μ | ±10, ±20 | 10 | 150 | 0.3±0.03 | R | |
| JMK063ABJ105MP-F | | | X5R | 1 μ | ±20 | 10 | 150 | 0.3±0.05 | R | |
| AMK063 BJ224[P-F] | | | 4 | | X5R | 0.22 μ | ±10, ±20 | 10 | 150 | 0.3±0.03 |
| AMK063 BJ334MP-F | | X5R | | 0.33 μ | ±20 | 10 | 150 | 0.3±0.03 | R | |
| AMK063 BJ474[P-F] | | X5R | | 0.47 μ | ±10, ±20 | 10 | 150 | 0.3±0.03 | R | |
| AMK063ABJ105MP-F | | X5R | | 1 μ | ±20 | 10 | 150 | 0.3±0.05 | R | |

[Temperature Characteristic C6 : X6S] 0.3mm thickness(P)

| Part number 1 | Part number 2 | Rated voltage [V] | Temperature characteristics | | Capacitance [F] | Capacitance tolerance [%] | tan δ [%] | HTLT | Thickness ³ [mm] | Soldering R:Reflow W:Wave |
|-------------------|---------------|-------------------|-----------------------------|---------|-----------------|---------------------------|-----------|-------------------|-----------------------------|---------------------------|
| | | | | | | | | Rated voltage x % | | |
| TMK063 C6104[P-F] | | 25 | | X6S | 0.1 μ | ±10, ±20 | 10 | 150 | 0.3±0.03 | R |
| EMK063AC6104[P-F] | | 16 | | X6S | 0.1 μ | ±10, ±20 | 10 | 150 | 0.3±0.05 | R |
| LMK063 C6333[P-F] | | | X6S | 33000 p | ±10, ±20 | 7.5 | 150 | 0.3±0.03 | R | |
| LMK063 C6473[P-F] | | 10 | | X6S | 47000 p | ±10, ±20 | 7.5 | 150 | 0.3±0.03 | R |
| LMK063 C6683[P-F] | | | X6S | 68000 p | ±10, ±20 | 10 | 150 | 0.3±0.03 | R | |
| LMK063 C6104[P-F] | | | X6S | 0.1 μ | ±10, ±20 | 10 | 150 | 0.3±0.03 | R | |
| LMK063 C6224[P-F] | | | X6S | 0.22 μ | ±10, ±20 | 10 | 150 | 0.3±0.03 | R | |
| JMK063 C6333[P-F] | | 6.3 | | X6S | 33000 p | ±10, ±20 | 7.5 | 150 | 0.3±0.03 | R |
| JMK063 C6473[P-F] | | | X6S | 47000 p | ±10, ±20 | 7.5 | 150 | 0.3±0.03 | R | |
| JMK063 C6683[P-F] | | | X6S | 68000 p | ±10, ±20 | 10 | 150 | 0.3±0.03 | R | |
| JMK063 C6104[P-F] | | | X6S | 0.1 μ | ±10, ±20 | 10 | 150 | 0.3±0.03 | R | |
| JMK063 C6224[P-F] | | | X6S | 0.22 μ | ±10, ±20 | 10 | 150 | 0.3±0.03 | R | |
| AMK063 C6474MP-F | | | 4 | | X6S | 0.47 μ | ±20 | 10 | 150 | 0.3±0.03 |
| AMK063AC6105MP-F | | X6S | | 1 μ | ±20 | 10 | 150 | 0.3±0.05 | R | |

[Temperature Characteristic B7 : X7R] 0.3mm thickness(P)

| Part number 1 | Part number 2 | Rated voltage [V] | Temperature characteristics | | Capacitance [F] | Capacitance tolerance [%] | tan δ [%] | HTLT | Thickness ³ [mm] | Soldering R:Reflow W:Wave | |
|-------------------|---------------|-------------------|-----------------------------|---------|-----------------|---------------------------|-----------|-------------------|-----------------------------|---------------------------|---|
| | | | | | | | | Rated voltage x % | | | |
| UMK063 B7101[P-F] | | 50 | | X7R | 100 p | ±10, ±20 | 3.5 | 200 | 0.3±0.03 | R | |
| UMK063 B7151[P-F] | | | X7R | 150 p | ±10, ±20 | 3.5 | 200 | 0.3±0.03 | R | | |
| UMK063 B7221[P-F] | | | X7R | 220 p | ±10, ±20 | 3.5 | 200 | 0.3±0.03 | R | | |
| UMK063 B7331[P-F] | | | X7R | 330 p | ±10, ±20 | 3.5 | 200 | 0.3±0.03 | R | | |
| UMK063 B7471[P-F] | | | X7R | 470 p | ±10, ±20 | 3.5 | 200 | 0.3±0.03 | R | | |
| UMK063 B7681[P-F] | | | X7R | 680 p | ±10, ±20 | 3.5 | 200 | 0.3±0.03 | R | | |
| UMK063 B7102[P-F] | | | X7R | 1000 p | ±10, ±20 | 3.5 | 200 | 0.3±0.03 | R | | |
| TMK063 B7152[P-F] | | | 25 | | X7R | 1500 p | ±10, ±20 | 5 | 200 | 0.3±0.03 | R |
| TMK063 B7222[P-F] | | | | X7R | 2200 p | ±10, ±20 | 5 | 200 | 0.3±0.03 | R | |
| TMK063 B7332[P-F] | | | | X7R | 3300 p | ±10, ±20 | 5 | 200 | 0.3±0.03 | R | |
| TMK063 B7472[P-F] | | X7R | | 4700 p | ±10, ±20 | 5 | 200 | 0.3±0.03 | R | | |
| TMK063 B7682[P-F] | | X7R | | 6800 p | ±10, ±20 | 5 | 200 | 0.3±0.03 | R | | |
| TMK063 B7103[P-F] | | X7R | | 10000 p | ±10, ±20 | 5 | 200 | 0.3±0.03 | R | | |
| EMK063 B7152[P-F] | | 16 | | X7R | 1500 p | ±10, ±20 | 5 | 200 | 0.3±0.03 | R | |
| EMK063 B7222[P-F] | | | X7R | 2200 p | ±10, ±20 | 5 | 200 | 0.3±0.03 | R | | |
| EMK063 B7332[P-F] | | | X7R | 3300 p | ±10, ±20 | 5 | 200 | 0.3±0.03 | R | | |
| EMK063 B7472[P-F] | | | X7R | 4700 p | ±10, ±20 | 5 | 200 | 0.3±0.03 | R | | |
| EMK063 B7682[P-F] | | | X7R | 6800 p | ±10, ±20 | 5 | 200 | 0.3±0.03 | R | | |
| EMK063 B7103[P-F] | | | X7R | 10000 p | ±10, ±20 | 5 | 200 | 0.3±0.03 | R | | |
| EMK063 B7223[P-F] | | | X7R | 22000 p | ±10, ±20 | 7.5 | 150 | 0.3±0.03 | R | | |

● 105TYPE

[Temperature Characteristic BJ : B/X5R] 0.5mm thickness(V)

| Part number 1 | Part number 2 | Rated voltage [V] | Temperature characteristics | | Capacitance [F] | Capacitance tolerance [%] | tan δ [%] | HTLT | Thickness ³ [mm] | Soldering R:Reflow W:Wave | |
|-------------------|---------------|-------------------|-----------------------------|-------------------|-----------------|---------------------------|-----------|-------------------|-----------------------------|---------------------------|---|
| | | | | | | | | Rated voltage x % | | | |
| UMK105 BJ221[V-F] | | 50 | B | X5R ¹⁾ | 220 p | ±10, ±20 | 2.5 | 200 | 0.5±0.05 | R | |
| UMK105 BJ331[V-F] | | | B | X5R ¹⁾ | 330 p | ±10, ±20 | 2.5 | 200 | 0.5±0.05 | R | |
| UMK105 BJ471[V-F] | | | B | X5R ¹⁾ | 470 p | ±10, ±20 | 2.5 | 200 | 0.5±0.05 | R | |
| UMK105 BJ681[V-F] | | | B | X5R ¹⁾ | 680 p | ±10, ±20 | 2.5 | 200 | 0.5±0.05 | R | |
| UMK105 BJ102[V-F] | | | B | X5R ¹⁾ | 1000 p | ±10, ±20 | 2.5 | 200 | 0.5±0.05 | R | |
| UMK105 BJ152[V-F] | | | B | X5R ¹⁾ | 1500 p | ±10, ±20 | 2.5 | 200 | 0.5±0.05 | R | |
| UMK105 BJ222[V-F] | | | B | X5R ¹⁾ | 2200 p | ±10, ±20 | 2.5 | 200 | 0.5±0.05 | R | |
| UMK105 BJ332[V-F] | | | B | X5R ¹⁾ | 3300 p | ±10, ±20 | 2.5 | 200 | 0.5±0.05 | R | |
| UMK105 BJ472[V-F] | | | B | X5R ¹⁾ | 4700 p | ±10, ±20 | 2.5 | 200 | 0.5±0.05 | R | |
| UMK105 BJ682[V-F] | | | B | X5R ¹⁾ | 6800 p | ±10, ±20 | 2.5 | 150 | 0.5±0.05 | R | |
| UMK105 BJ103[V-F] | | | B | X5R ¹⁾ | 10000 p | ±10, ±20 | 3.5 | 200 | 0.5±0.05 | R | |
| UMK105 BJ104[V-F] | | | | X5R | 0.1 μ | ±10, ±20 | 10 | 150 | 0.5±0.05 | R | |
| UMK105 BJ224[V-F] | | | | X5R | 0.22 μ | ±10, ±20 | 10 | 150 | 0.5±0.05 | R | |
| UMK105ABJ474[V-F] | | | | X5R | 0.47 μ | ±10, ±20 | 10 | 150 | 0.5±0.10 | R | |
| UMK105CBJ105MV-F | | | | X5R | 1 μ | ±20 | 10 | 150 | 0.5+0.20/-0 | R | |
| GMK105 BJ104[V-F] | | | 35 | B | X5R | 0.1 μ | ±10, ±20 | 5 | 150 | 0.5±0.05 | R |
| GMK105ABJ105[V-F] | | | | X5R | 1 μ | ±10, ±20 | 10 | 150 | 0.5±0.10 | R | |

▶ This catalog contains the typical specification only due to the limitation of space. When you consider the purchase of our products, please check our specification. For details of each product (characteristics graph, reliability information, precautions for use, and so on), see our Web site (<http://www.ty-top.com/>).

PARTS NUMBER

| Part number 1 | Part number 2 | Rated voltage [V] | Temperature characteristics | | Capacitance [F] | Capacitance tolerance [%] | tan δ [%] | HTLT | Thickness*3 [mm] | Soldering R:Reflow W:Wave | | |
|------------------|-------------------|-------------------|-----------------------------|-------|-----------------|---------------------------|-----------|-------------------|------------------|---------------------------|-------------|---|
| | | | | | | | | Rated voltage x % | | | | |
| TMK105 BJ153□V-F | | 25 | B | X5R*1 | 15000 p | ±10, ±20 | 3.5 | 200 | 0.5±0.05 | R | | |
| TMK105 BJ223□V-F | | | B | X5R*1 | 22000 p | ±10, ±20 | 3.5 | 200 | 0.5±0.05 | R | | |
| TMK105 BJ333□V-F | | | B | X5R*1 | 33000 p | ±10, ±20 | 3.5 | 150 | 0.5±0.05 | R | | |
| TMK105 BJ473□V-F | | | B | X5R*1 | 47000 p | ±10, ±20 | 3.5 | 150 | 0.5±0.05 | R | | |
| TMK105 BJ104□V-F | | | B | X5R | 0.1 μ | ±10, ±20 | 5 | 150 | 0.5±0.05 | R | | |
| TMK105 BJ224□V-F | | | | X5R | 0.22 μ | ±10, ±20 | 10 | 200 | 0.5±0.05 | R | | |
| TMK105ABJ474□V-F | | | | X5R | 0.47 μ | ±10, ±20 | 10 | 200 | 0.5±0.10 | R | | |
| TMK105 BJ105□V-F | | | | X5R | 1 μ | ±10, ±20 | 10 | 150 | 0.5±0.05 | R | | |
| TMK105CBJ225MV-F | | | | X5R | 2.2 μ | ±20 | 10 | 150 | 0.5+0.20/-0 | R | | |
| EMK105 BJ153□V-F | | | 16 | B | X5R*1 | 15000 p | ±10, ±20 | 3.5 | 200 | 0.5±0.05 | R | |
| EMK105 BJ223□V-F | | | | B | X5R*1 | 22000 p | ±10, ±20 | 3.5 | 200 | 0.5±0.05 | R | |
| EMK105 BJ333□V-F | | | | B | X5R*1 | 33000 p | ±10, ±20 | 3.5 | 200 | 0.5±0.05 | R | |
| EMK105 BJ473□V-F | | | | B | X5R*1 | 47000 p | ±10, ±20 | 3.5 | 200 | 0.5±0.05 | R | |
| EMK105 BJ683□V-F | | | | B | X5R | 68000 p | ±10, ±20 | 5 | 200 | 0.5±0.05 | R | |
| EMK105 BJ104□V-F | | B | | X5R*1 | 0.1 μ | ±10, ±20 | 5 | 150 | 0.5±0.05 | R | | |
| EMK105 BJ224□V-F | | B | | X5R | 0.22 μ | ±10, ±20 | 5 | 150 | 0.5±0.05 | R | | |
| EMK105ABJ474□V-F | | | | X5R | 0.47 μ | ±10, ±20 | 10 | 150 | 0.5±0.10 | R | | |
| EMK105 BJ105□V-F | | | | X5R | 1 μ | ±10, ±20 | 10 | 150 | 0.5±0.05 | R | | |
| EMK105ABJ225MV-F | | | | X5R | 2.2 μ | ±20 | 10 | 150 | 0.5±0.10 | R | | |
| LMK105 BJ104□V-F | | 10 | | B | X5R | 0.1 μ | ±10, ±20 | 5 | 200 | 0.5±0.05 | R | |
| LMK105 BJ224□V-F | | | | B | X5R | 0.22 μ | ±10, ±20 | 5 | 150 | 0.5±0.05 | R | |
| LMK105 BJ474□V-F | | | | | X5R | 0.47 μ | ±10, ±20 | 10 | 150 | 0.5±0.05 | R | |
| LMK105 BJ105□V-F | | | | | X5R | 1 μ | ±10, ±20 | 10 | 150 | 0.5±0.05 | R | |
| LMK105 BJ225MV-F | | | | X5R | 2.2 μ | ±20 | 10 | 150 | 0.5±0.05 | R | | |
| LMK105BBJ475MVF | | | | X5R | 4.7 μ | ±20 | 10 | 150 | 0.5+0.15/-0.05 | R | | |
| JMK105 BJ224□V-F | | | 6.3 | B | X5R | 0.22 μ | ±10, ±20 | 5 | 150 | 0.5±0.05 | R | |
| JMK105 BJ474□V-F | | | | | X5R | 0.47 μ | ±10, ±20 | 10 | 150 | 0.5±0.05 | R | |
| JMK105 BJ105□V-F | | | | | X5R | 1 μ | ±10, ±20 | 10 | 150 | 0.5±0.05 | R | |
| JMK105 BJ225MV-F | | | | | X5R | 2.2 μ | ±20 | 10 | 150 | 0.5±0.05 | R | |
| JMK105BBJ475MVF | JMK105 BJ475MV-FD | | | | X5R | 4.7 μ | ±20 | 10 | 150 | 0.5+0.15/-0.05 | R | |
| JMK105CBJ106MV-F | | | | | X5R | 10 μ | ±20 | 10 | 150 | 0.5+0.20/-0 | R | |
| AMK105ABJ475MV-F | AMK105 BJ475MV-F | | | 4 | | X5R | 4.7 μ | ±20 | 10 | 150 | 0.5±0.10 | R |
| AMK105CBJ106MV-F | | | | | | X5R | 10 μ | ±20 | 10 | 150 | 0.5+0.20/-0 | R |

【Temperature Characteristic BJ : B/X5R】 0.3mm thickness (P)

| Part number 1 | Part number 2 | Rated voltage [V] | Temperature characteristics | | Capacitance [F] | Capacitance tolerance [%] | tan δ [%] | HTLT | Thickness*3 [mm] | Soldering R:Reflow W:Wave | |
|------------------|---------------|-------------------|-----------------------------|-----|-----------------|---------------------------|-----------|-------------------|------------------|---------------------------|---|
| | | | | | | | | Rated voltage x % | | | |
| UMK105 BJ104□P-F | | 50 | | X5R | 0.1 μ | ±10, ±20 | 10 | 150 | 0.3±0.03 | R | |
| TMK105 BJ103□P-F | | | | B | X5R | 10000 p | ±10, ±20 | 5 | 150 | 0.3±0.03 | R |
| TMK105 BJ104□P-F | | | 25 | | X5R | 0.1 μ | ±10, ±20 | 10 | 150 | 0.3±0.03 | R |
| TMK105 BJ224□P-F | | | | | X5R | 0.22 μ | ±10, ±20 | 10 | 150 | 0.3±0.03 | R |
| TMK105 BJ474□P-F | | 16 | | X5R | 0.47 μ | ±10, ±20 | 10 | 150 | 0.3±0.03 | R | |
| EMK105 BJ474□P-F | | | | X5R | 0.47 μ | ±10, ±20 | 10 | 150 | 0.3±0.03 | R | |
| LMK105 BJ105□PLF | | 10 | | X5R | 1 μ | ±10, ±20 | 10 | 150 | 0.3±0.03 | R | |
| JMK105 BJ105□P-F | | 6.3 | | X5R | 1 μ | ±10, ±20 | 10 | 150 | 0.3±0.03 | R | |
| AMK105 BJ225MP-F | | 4 | | X5R | 2.2 μ | ±20 | 10 | 150 | 0.3±0.03 | R | |

【Temperature Characteristic BJ : X5R】 0.2mm thickness (C)

| Part number 1 | Part number 2 | Rated voltage [V] | Temperature characteristics | | Capacitance [F] | Capacitance tolerance [%] | tan δ [%] | HTLT | Thickness*3 [mm] | Soldering R:Reflow W:Wave |
|------------------|---------------|-------------------|-----------------------------|-----|-----------------|---------------------------|-----------|-------------------|------------------|---------------------------|
| | | | | | | | | Rated voltage x % | | |
| LMK105 BJ104□C-F | | 10 | | X5R | 0.1 μ | ±10, ±20 | 10 | 150 | 0.2±0.02 | R |
| JMK105 BJ224□C-F | | | | | X5R | 0.22 μ | ±10, ±20 | 10 | 150 | 0.2±0.02 |
| JMK105 BJ474□C-F | | 6.3 | | X5R | 0.47 μ | ±10, ±20 | 10 | 150 | 0.2±0.02 | R |
| JMK105 BJ105MC-F | | | | | X5R | 1 μ | ±20 | 10 | 150 | 0.2±0.02 |

【Temperature Characteristic C6 : X6S】 0.5mm thickness (V)

| Part number 1 | Part number 2 | Rated voltage [V] | Temperature characteristics | | Capacitance [F] | Capacitance tolerance [%] | tan δ [%] | HTLT | Thickness*3 [mm] | Soldering R:Reflow W:Wave |
|------------------|---------------|-------------------|-----------------------------|-----|-----------------|---------------------------|-----------|-------------------|------------------|---------------------------|
| | | | | | | | | Rated voltage x % | | |
| TMK105CC6105MV-F | | 25 | | X6S | 1 μ | ±20 | 10 | 150 | 0.5+0.20/-0 | R |
| EMK105 C6105□V-F | | | | | X6S | 1 μ | ±10, ±20 | 10 | 150 | 0.5±0.05 |
| EMK105CC6225MV-F | | 16 | | X6S | 2.2 μ | ±20 | 10 | 150 | 0.5+0.20/-0 | R |
| LMK105 C6105□V-F | | | | | X6S | 1 μ | ±10, ±20 | 10 | 200 | 0.5±0.05 |
| LMK105AC6225MV-F | | 10 | | X6S | 2.2 μ | ±20 | 10 | 150 | 0.5±0.10 | R |
| JMK105 C6105□V-F | | | | | X6S | 1 μ | ±10, ±20 | 10 | 150 | 0.5±0.05 |
| JMK105 C6225MV-F | | 6.3 | | X6S | 2.2 μ | ±20 | 10 | 150 | 0.5±0.05 | R |
| JMK105BC6475MV-F | | | | | X6S | 4.7 μ | ±20 | 10 | 150 | 0.5+0.15/-0.05 |
| AMK105BC6475MV-F | | 4 | | X6S | 4.7 μ | ±20 | 10 | 150 | 0.5+0.15/-0.05 | R |

【Temperature Characteristic B7 : X7R】 0.5mm thickness (V)

| Part number 1 | Part number 2 | Rated voltage [V] | Temperature characteristics | | Capacitance [F] | Capacitance tolerance [%] | tan δ [%] | HTLT | Thickness*3 [mm] | Soldering R:Reflow W:Wave | | |
|-------------------|---------------|-------------------|-----------------------------|-----|-----------------|---------------------------|-----------|-------------------|------------------|---------------------------|----------|---|
| | | | | | | | | Rated voltage x % | | | | |
| UMK105 B7221□V-F | | 50 | | X7R | 220 p | ±10, ±20 | 2.5 | 200 | 0.5±0.05 | R | | |
| UMK105 B7331□V-F | | | | | X7R | 330 p | ±10, ±20 | 2.5 | 200 | 0.5±0.05 | R | |
| UMK105 B7471□V-F | | | | | X7R | 470 p | ±10, ±20 | 2.5 | 200 | 0.5±0.05 | R | |
| UMK105 B7681□V-F | | | | | X7R | 680 p | ±10, ±20 | 2.5 | 200 | 0.5±0.05 | R | |
| UMK105 B7102□V-F | | | | | X7R | 1000 p | ±10, ±20 | 2.5 | 200 | 0.5±0.05 | R | |
| UMK105 B7152□V-F | | | | | X7R | 1500 p | ±10, ±20 | 2.5 | 200 | 0.5±0.05 | R | |
| UMK105 B7222□V-F | | | | | X7R | 2200 p | ±10, ±20 | 2.5 | 200 | 0.5±0.05 | R | |
| UMK105 B7332□V-F | | | | | X7R | 3300 p | ±10, ±20 | 2.5 | 200 | 0.5±0.05 | R | |
| UMK105 B7472□V-F | | | | | X7R | 4700 p | ±10, ±20 | 2.5 | 200 | 0.5±0.05 | R | |
| UMK105 B7682□V-F | | | | | X7R | 6800 p | ±10, ±20 | 2.5 | 200 | 0.5±0.05 | R | |
| UMK105 B7103□V-F | | | | | X7R | 10000 p | ±10, ±20 | 3.5 | 200 | 0.5±0.05 | R | |
| UMK105 B7104□V-FR | | | | | X7R | 0.1 μ | ±10, ±20 | 10 | 150 | 0.5±0.05 | R | |
| TMK105 B7152□V-F | | | 25 | | X7R | 1500 p | ±10, ±20 | 2.5 | 200 | 0.5±0.05 | R | |
| TMK105 B7222□V-F | | | | | | X7R | 2200 p | ±10, ±20 | 2.5 | 200 | 0.5±0.05 | R |
| TMK105 B7332□V-F | | | | | | X7R | 3300 p | ±10, ±20 | 2.5 | 200 | 0.5±0.05 | R |
| TMK105 B7472□V-F | | | | | | X7R | 4700 p | ±10, ±20 | 2.5 | 200 | 0.5±0.05 | R |
| TMK105 B7682□V-F | | | | | | X7R | 6800 p | ±10, ±20 | 2.5 | 200 | 0.5±0.05 | R |

▶ This catalog contains the typical specification only due to the limitation of space. When you consider the purchase of our products, please check our specification. For details of each product (characteristics graph, reliability information, precautions for use, and so on), see our Web site (<http://www.ty-top.com/>).

● PARTS NUMBER

| Part number 1 | Part number 2 | Rated voltage [V] | Temperature characteristics | | Capacitance [F] | Capacitance tolerance [%] | tan δ [%] | HTLT | Thickness*3 [mm] | Soldering R:Reflow W:Wave |
|--------------------|---------------|-------------------|-----------------------------|---------|-----------------|---------------------------|-----------|-------------------|------------------|---------------------------|
| | | | | | | | | Rated voltage x % | | |
| TMK105 B7103[V-F] | | 25 | | X7R | 10000 p | ±10, ±20 | 3.5 | 200 | 0.5±0.05 | R |
| TMK105 B7104[V-FR] | | | X7R | 0.1 μ | ±10, ±20 | 10 | 200 | 0.5±0.05 | R | |
| TMK105 B7224[V-FR] | | | X7R | 0.22 μ | ±10, ±20 | 10 | 150 | 0.5±0.05 | R | |
| EMK105 B7223[V-F] | | 16 | | X7R | 22000 p | ±10, ±20 | 3.5 | 200 | 0.5±0.05 | R |
| EMK105 B7473[V-F] | | | X7R | 47000 p | ±10, ±20 | 3.5 | 200 | 0.5±0.05 | R | |
| EMK105 B7104[V-F] | | | X7R | 0.1 μ | ±10, ±20 | 5 | 150 | 0.5±0.05 | R | |
| EMK105 B7224[V-FR] | | 10 | | X7R | 0.22 μ | ±10, ±20 | 10 | 150 | 0.5±0.05 | R |
| LMK105 B7223[V-F] | | | X7R | 22000 p | ±10, ±20 | 3.5 | 200 | 0.5±0.05 | R | |
| LMK105 B7473[V-F] | | | X7R | 47000 p | ±10, ±20 | 3.5 | 200 | 0.5±0.05 | R | |
| LMK105 B7104[V-F] | | 6.3 | | X7R | 0.1 μ | ±10, ±20 | 5 | 150 | 0.5±0.05 | R |
| LMK105 B7224[V-FR] | | | X7R | 0.22 μ | ±10, ±20 | 10 | 150 | 0.5±0.05 | R | |
| LMK105 B7474[V-F] | | | X7R | 0.47 μ | ±10, ±20 | 10 | 150 | 0.5±0.05 | R | |
| JMK105 B7224[V-F] | | 6.3 | | X7R | 0.22 μ | ±10, ±20 | 5 | 150 | 0.5±0.05 | R |
| JMK105 B7474[V-F] | | | X7R | 0.47 μ | ±10, ±20 | 10 | 150 | 0.5±0.05 | R | |

[Temperature Characteristic F : F/Y5V] 0.5mm thickness (V)

| Part number 1 | Part number 2 | Rated voltage [V] | Temperature characteristics | | Capacitance [F] | Capacitance tolerance [%] | tan δ [%] | HTLT | Thickness*3 [mm] | Soldering R:Reflow W:Wave |
|-----------------|---------------|-------------------|-----------------------------|-----|-----------------|---------------------------|-----------|-------------------|------------------|---------------------------|
| | | | | | | | | Rated voltage x % | | |
| UMK105 F103ZV-F | | 50 | F | Y5V | 10000 p | +80/-20 | 5 | 200 | 0.5±0.05 | R |
| TMK105 F223ZV-F | | 25 | F | Y5V | 22000 p | +80/-20 | 5 | 200 | 0.5±0.05 | R |
| EMK105 F473ZV-F | | | F | Y5V | 47000 p | +80/-20 | 7 | 200 | 0.5±0.05 | R |
| EMK105 F104ZV-F | | 16 | F | Y5V | 0.1 μ | +80/-20 | 9 | 200 | 0.5±0.05 | R |
| LMK105 F224ZV-F | | | F | Y5V | 0.22 μ | +80/-20 | 11 | 200 | 0.5±0.05 | R |
| JMK105 F474ZV-F | | 6.3 | F | Y5V | 0.47 μ | +80/-20 | 12.5 | 200 | 0.5±0.05 | R |
| JMK105 F105ZV-F | | | F | Y5V | 1 μ | +80/-20 | 20 | 150 | 0.5±0.05 | R |

● 107TYPE

[Temperature Characteristic BJ : B/X5R] 0.8mm thickness (A)

| Part number 1 | Part number 2 | Rated voltage [V] | Temperature characteristics | | Capacitance [F] | Capacitance tolerance [%] | tan δ [%] | HTLT | Thickness*3 [mm] | Soldering R:Reflow W:Wave |
|-------------------|--------------------|-------------------|-----------------------------|------------------|-----------------|---------------------------|-----------|-------------------|------------------|---------------------------|
| | | | | | | | | Rated voltage x % | | |
| UMK107ABJ474[A-T] | UMK107 BJ474[A-TD] | 50 | | X5R | 0.47 μ | ±10, ±20 | 10 | 150 | 0.8+0.15/-0.05 | R |
| UMK107 BJ105[A-T] | | | X5R | 1 μ | ±10, ±20 | 10 | 150 | 0.8±0.10 | R | |
| UMK107BBJ225[A-T] | | | X5R | 2.2 μ | ±10, ±20 | 10 | 150 | 0.8+0.20/-0 | R | |
| GMK107 BJ105[A-T] | | 35 | B | X5R | 1 μ | ±10, ±20 | 5 | 150 | 0.8±0.10 | R |
| TMK107 BJ224[A-T] | | | B | X5R | 0.22 μ | ±10, ±20 | 3.5 | 200 | 0.8±0.10 | R/W |
| TMK107 BJ474[A-T] | | | B | X5R | 0.47 μ | ±10, ±20 | 3.5 | 150 | 0.8±0.10 | R |
| TMK107 BJ105[A-T] | | 25 | B | X5R | 1 μ | ±10, ±20 | 5 | 150 | 0.8±0.10 | R |
| TMK107ABJ225[A-T] | TMK107 BJ225[A-TD] | | X5R | 2.2 μ | ±10, ±20 | 10 | 150 | 0.8+0.15/-0.05 | R | |
| TMK107BBJ475[A-T] | | | X5R | 4.7 μ | ±10, ±20 | 10 | 150 | 0.8+0.20/-0 | R | |
| EMK107 BJ224[A-T] | | 16 | B | X5R ¹ | 0.22 μ | ±10, ±20 | 3.5 | 200 | 0.8±0.10 | R/W |
| EMK107 BJ474[A-T] | | | B | X5R ¹ | 0.47 μ | ±10, ±20 | 3.5 | 200 | 0.8±0.10 | R |
| EMK107 BJ105[A-T] | | | B | X5R ¹ | 1 μ | ±10, ±20 | 5 | 150 | 0.8±0.10 | R |
| EMK107 BJ225[A-T] | | 10 | B | X5R | 2.2 μ | ±10, ±20 | 10 | 150 | 0.8±0.10 | R |
| EMK107ABJ475[A-T] | EMK107 BJ475[A-TD] | | X5R | 4.7 μ | ±10, ±20 | 10 | 150 | 0.8+0.15/-0.05 | R | |
| EMK107BBJ106MA-T | | | X5R | 10 μ | ±20 | 10 | 150 | 0.8+0.20/-0 | R | |
| LMK107 BJ224[A-T] | | 6.3 | B | X5R ¹ | 0.22 μ | ±10, ±20 | 3.5 | 200 | 0.8±0.10 | R/W |
| LMK107 BJ474[A-T] | | | B | X5R ¹ | 0.47 μ | ±10, ±20 | 3.5 | 200 | 0.8±0.10 | R |
| LMK107 BJ105[A-T] | | | B | X5R ¹ | 1 μ | ±10, ±20 | 5 | 200 | 0.8±0.10 | R |
| LMK107 BJ225[A-T] | | 10 | B | X5R | 2.2 μ | ±10, ±20 | 10 | 150 | 0.8±0.10 | R |
| LMK107 BJ475[A-T] | | | X5R | 4.7 μ | ±10, ±20 | 10 | 150 | 0.8±0.10 | R | |
| LMK107BBJ106MALT | LMK107 BJ106MALT | | X5R | 10 μ | ±20 | 10 | 150 | 0.8+0.20/-0 | R | |
| JMK107 BJ225[A-T] | | 6.3 | B | X5R | 2.2 μ | ±10, ±20 | 10 | 150 | 0.8±0.10 | R |
| JMK107 BJ475[A-T] | | | X5R | 4.7 μ | ±10, ±20 | 10 | 150 | 0.8±0.10 | R | |
| JMK107ABJ106MA-T | JMK107 BJ106MA-T | | X5R | 10 μ | ±20 | 10 | 150 | 0.8+0.15/-0.05 | R | |
| AMK107 BJ106MA-T | | 4 | | X5R | 10 μ | ±20 | 10 | 150 | 0.8±0.10 | R |
| AMK107BBJ226MA-T | AMK107 BJ226MA-T | | X5R | 22 μ | ±20 | 10 | 150 | 0.8+0.20/-0 | R | |

[Temperature Characteristic BJ : B/X5R] 0.45mm thickness (K)

| Part number 1 | Part number 2 | Rated voltage [V] | Temperature characteristics | | Capacitance [F] | Capacitance tolerance [%] | tan δ [%] | HTLT | Thickness*3 [mm] | Soldering R:Reflow W:Wave |
|-------------------|-------------------|-------------------|-----------------------------|-------|-----------------|---------------------------|-----------|-------------------|------------------|---------------------------|
| | | | | | | | | Rated voltage x % | | |
| TMK107 BJ105[K-T] | | 25 | | X5R | 1 μ | ±10, ±20 | 10 | 150 | 0.45±0.05 | R |
| EMK107 BJ105[K-T] | | 16 | | X5R | 1 μ | ±10, ±20 | 10 | 150 | 0.45±0.05 | R |
| EMK107BBJ225[K-T] | | | X5R | 2.2 μ | ±10, ±20 | 10 | 150 | 0.45±0.05 | R | |
| LMK107 BJ105[K-T] | | 10 | B | X5R | 1 μ | ±10, ±20 | 10 | 150 | 0.45±0.05 | R |
| LMK107 BJ225[K-T] | | | X5R | 2.2 μ | ±10, ±20 | 10 | 150 | 0.45±0.05 | R | |
| LMK107BBJ475MKLT | LMK107 BJ475MKLTD | | X5R | 4.7 μ | ±20 | 10 | 150 | 0.45±0.05 | R | |
| JMK107 BJ105[K-T] | | 6.3 | B | X5R | 1 μ | ±10, ±20 | 10 | 150 | 0.45±0.05 | R |
| JMK107 BJ225[K-T] | | | X5R | 2.2 μ | ±10, ±20 | 10 | 150 | 0.45±0.05 | R | |
| JMK107 BJ475MK-T | | | X5R | 4.7 μ | ±20 | 10 | 150 | 0.45±0.05 | R | |
| JMK107BBJ106MK-T | | 4 | | X5R | 10 μ | ±20 | 10 | 150 | 0.45±0.05 | R |
| AMK107BBJ106MK-T | | | X5R | 10 μ | ±20 | 10 | 150 | 0.45±0.05 | R | |

[Temperature Characteristic C6 : X6S] 0.8mm thickness (A)

| Part number 1 | Part number 2 | Rated voltage [V] | Temperature characteristics | | Capacitance [F] | Capacitance tolerance [%] | tan δ [%] | HTLT | Thickness*3 [mm] | Soldering R:Reflow W:Wave |
|-------------------|---------------|-------------------|-----------------------------|-------|-----------------|---------------------------|-----------|-------------------|------------------|---------------------------|
| | | | | | | | | Rated voltage x % | | |
| TMK107BC6225[A-T] | | 25 | | X6S | 2.2 μ | ±10, ±20 | 10 | 150 | 0.8+0.20/-0 | R |
| EMK107 C6105[A-T] | | 16 | | X6S | 1 μ | ±10, ±20 | 5 | 150 | 0.8±0.10 | R |
| EMK107BC6225[A-T] | | | X6S | 2.2 μ | ±10, ±20 | 10 | 150 | 0.8+0.20/-0 | R | |
| EMK107BC6475[A-T] | | | X6S | 4.7 μ | ±10, ±20 | 10 | 150 | 0.8+0.20/-0 | R | |
| LMK107 C6105[A-T] | | 10 | | X6S | 1 μ | ±10, ±20 | 5 | 150 | 0.8±0.10 | R |
| LMK107AC6475[A-T] | | | X6S | 4.7 μ | ±10, ±20 | 10 | 150 | 0.8+0.15/-0.05 | R | |
| LMK107BC6106MA-T | | | X6S | 10 μ | ±20 | 10 | 150 | 0.8+0.20/-0 | R | |
| JMK107 C6105[A-T] | | 6.3 | | X6S | 1 μ | ±10, ±20 | 5 | 150 | 0.8±0.10 | R |
| JMK107 C6475[A-T] | | | X6S | 4.7 μ | ±10, ±20 | 10 | 150 | 0.8±0.10 | R | |
| JMK107BC6106MA-T | | | X6S | 10 μ | ±20 | 10 | 150 | 0.8+0.20/-0 | R | |
| AMK107AC6106MA-T | | 4 | | X6S | 10 μ | ±20 | 10 | 150 | 0.8+0.15/-0.05 | R |

▶ This catalog contains the typical specification only due to the limitation of space. When you consider the purchase of our products, please check our specification. For details of each product (characteristics graph, reliability information, precautions for use, and so on), see our Web site (<http://www.ty-top.com/>).

PARTS NUMBER

[Temperature Characteristic B7 : X7R] 0.8mm thickness(A)

| Part number 1 | Part number 2 | Rated voltage [V] | Temperature characteristics | | Capacitance [F] | Capacitance tolerance [%] | tan δ [%] | HTLT | Thickness*3 [mm] | Soldering R:Reflow W:Wave |
|-------------------|---------------|-------------------|-----------------------------|-----|-----------------|---------------------------|-----------|-------------------|------------------|---------------------------|
| | | | | | | | | Rated voltage x % | | |
| UMK107 B7224□A-TR | | 50 | | X7R | 0.22 μ | ±10, ±20 | 10 | 150 | 0.8±0.10 | R |
| UMK107 B7474□A-TR | | | | X7R | 0.47 μ | ±10, ±20 | 10 | 150 | 0.8±0.10 | R |
| UMK107AB7105□A-T | | | | X7R | 1 μ | ±10, ±20 | 10 | 150 | 0.8±0.15/-0.05 | R |
| TMK107 B7474□A-TR | | 25 | | X7R | 0.47 μ | ±10, ±20 | 10 | 150 | 0.8±0.10 | R |
| TMK107 B7105□A-T | | | | X7R | 1 μ | ±10, ±20 | 10 | 150 | 0.8±0.10 | R |
| EMK107 B7224□A-T | | | | X7R | 0.22 μ | ±10, ±20 | 3.5 | 150 | 0.8±0.10 | R/W |
| EMK107 B7474□A-T | | 16 | | X7R | 0.47 μ | ±10, ±20 | 3.5 | 150 | 0.8±0.10 | R |
| EMK107 B7105□A-T | | | | X7R | 1 μ | ±10, ±20 | 5 | 150 | 0.8±0.10 | R |
| EMK107BB7225□A-T | | | | X7R | 2.2 μ | ±10, ±20 | 10 | 150 | 0.8±0.20/-0 | R |
| LMK107 B7224□A-T | | 10 | | X7R | 0.22 μ | ±10, ±20 | 3.5 | 200 | 0.8±0.10 | R/W |
| LMK107 B7474□A-T | | | | X7R | 0.47 μ | ±10, ±20 | 3.5 | 200 | 0.8±0.10 | R |
| LMK107 B7105□A-T | | | | X7R | 1 μ | ±10, ±20 | 5 | 150 | 0.8±0.10 | R |
| LMK107 B7225□A-TR | | 6.3 | | X7R | 2.2 μ | ±10, ±20 | 10 | 150 | 0.8±0.10 | R |
| JMK107 B7224□A-T | | | | X7R | 0.22 μ | ±10, ±20 | 3.5 | 200 | 0.8±0.10 | R/W |
| JMK107 B7474□A-T | | | | X7R | 0.47 μ | ±10, ±20 | 3.5 | 200 | 0.8±0.10 | R |
| JMK107 B7105□A-T | | 6.3 | | X7R | 1 μ | ±10, ±20 | 5 | 150 | 0.8±0.10 | R |
| JMK107 B7225□A-TR | | | | X7R | 2.2 μ | ±10, ±20 | 10 | 200 | 0.8±0.10 | R |
| JMK107BB7475□A-T | | | | X7R | 4.7 μ | ±10, ±20 | 10 | 150 | 0.8±0.20/-0 | R |

[Temperature Characteristic F : F/Y5V] 0.8mm thickness(A)

| Part number 1 | Part number 2 | Rated voltage [V] | Temperature characteristics | | Capacitance [F] | Capacitance tolerance [%] | tan δ [%] | HTLT | Thickness*3 [mm] | Soldering R:Reflow W:Wave |
|-----------------|---------------|-------------------|-----------------------------|-----|-----------------|---------------------------|-----------|-------------------|------------------|---------------------------|
| | | | | | | | | Rated voltage x % | | |
| UMK107 F104ZA-T | | 50 | F | Y5V | 0.1 μ | +80/-20 | 7 | 200 | 0.8±0.10 | R/W |
| TMK107 F474ZA-T | | 25 | F | Y5V | 0.47 μ | +80/-20 | 7 | 200 | 0.8±0.10 | R/W |
| EMK107 F224ZA-T | | 16 | F | Y5V | 0.22 μ | +80/-20 | 7 | 200 | 0.8±0.10 | R/W |
| EMK107 F474ZA-T | | | F | Y5V | 0.47 μ | +80/-20 | 7 | 200 | 0.8±0.10 | R/W |
| EMK107 F105ZA-T | | | F | Y5V | 1 μ | +80/-20 | 16 | 200 | 0.8±0.10 | R |
| EMK107 F225ZA-T | | 10 | F | Y5V | 2.2 μ | +80/-20 | 16 | 200 | 0.8±0.10 | R |
| LMK107 F105ZA-T | | | F | Y5V | 1 μ | +80/-20 | 16 | 200 | 0.8±0.10 | R |
| LMK107 F225ZA-T | | | F | Y5V | 2.2 μ | +80/-20 | 16 | 200 | 0.8±0.10 | R |

212TYPE

[Temperature Characteristic BJ : B/X5R] 1.25mm thickness(G)

| Part number 1 | Part number 2 | Rated voltage [V] | Temperature characteristics | | Capacitance [F] | Capacitance tolerance [%] | tan δ [%] | HTLT | Thickness*3 [mm] | Soldering R:Reflow W:Wave |
|------------------|------------------|-------------------|-----------------------------|------------------|-----------------|---------------------------|-----------|-------------------|------------------|---------------------------|
| | | | | | | | | Rated voltage x % | | |
| UMK212 BJ104□G-T | | 50 | B | X5R ⁺ | 0.1 μ | ±10, ±20 | 3.5 | 200 | 1.25±0.10 | R/W |
| UMK212 BJ224□G-T | | | B | X5R ⁺ | 0.22 μ | ±10, ±20 | 3.5 | 200 | 1.25±0.10 | R/W |
| UMK212 BJ474□G-T | | | B | X5R ⁺ | 0.47 μ | ±10, ±20 | 3.5 | 150 | 1.25±0.10 | R/W |
| UMK212 BJ105□G-T | | 25 | B | X5R | 1 μ | ±10, ±20 | 5 | 150 | 1.25±0.10 | R/W |
| UMK212ABJ225□G-T | | | B | X5R | 2.2 μ | ±10, ±20 | 10 | 150 | 1.25±0.15/-0.05 | R |
| UMK212BBJ475□G-T | | | B | X5R | 4.7 μ | ±10, ±20 | 10 | 150 | 1.25±0.20/-0 | R |
| TMK212 BJ225□G-T | | 16 | B | X5R | 2.2 μ | ±10, ±20 | 5 | 150 | 1.25±0.10 | R |
| TMK212ABJ475□G-T | TMK212 BJ475□G-T | | B | X5R | 4.7 μ | ±10, ±20 | 10 | 150 | 1.25±0.15/-0.05 | R |
| TMK212BBJ106MG-T | | | B | X5R | 10 μ | ±20 | 10 | 150 | 1.25±0.20/-0 | R |
| EMK212 BJ225□G-T | | 10 | B | X5R ⁺ | 2.2 μ | ±10, ±20 | 5 | 200 | 1.25±0.10 | R |
| EMK212ABJ475□G-T | EMK212 BJ475□G-T | | B | X5R ⁺ | 4.7 μ | ±10, ±20 | 5 | 150 | 1.25±0.15/-0.05 | R |
| EMK212ABJ106□G-T | EMK212 BJ106□G-T | | B | X5R | 10 μ | ±10, ±20 | 10 | 150 | 1.25±0.15/-0.05 | R |
| EMK212BBJ226MG-T | | 6.3 | B | X5R | 2.2 μ | ±20 | 10 | 150 | 1.25±0.20/-0 | R |
| LMK212 BJ225□G-T | | | B | X5R ⁺ | 2.2 μ | ±10, ±20 | 5 | 200 | 1.25±0.10 | R |
| LMK212ABJ475□G-T | LMK212 BJ475□G-T | | B | X5R ⁺ | 4.7 μ | ±10, ±20 | 5 | 200 | 1.25±0.15/-0.05 | R |
| LMK212ABJ106□G-T | LMK212 BJ106□G-T | 10 | B | X5R | 10 μ | ±10, ±20 | 10 | 200 | 1.25±0.15/-0.05 | R |
| LMK212ABJ226MG-T | LMK212 BJ226MG-T | | B | X5R | 2.2 μ | ±20 | 10 | 150 | 1.25±0.20/-0 | R |
| JMK212ABJ475□G-T | JMK212 BJ475□G-T | | B | X5R | 4.7 μ | ±10, ±20 | 5 | 200 | 1.25±0.15/-0.05 | R |
| JMK212ABJ106□G-T | JMK212 BJ106□G-T | 6.3 | B | X5R ⁺ | 10 μ | ±10, ±20 | 10 | 200 | 1.25±0.15/-0.05 | R |
| JMK212ABJ226MG-T | JMK212 BJ226MG-T | | B | X5R | 2.2 μ | ±20 | 10 | 150 | 1.25±0.15/-0.05 | R |
| JMK212BBJ476MG-T | JMK212 BJ476MG-T | | B | X5R | 4.7 μ | ±20 | 10 | 150 | 1.25±0.20/-0 | R |
| PMK212BBJ107MG-T | | 2.5 | | X5R | 100 μ | ±20 | 10 | 150 | 1.25±0.20/-0 | R |

[Temperature Characteristic BJ : B/X5R] 0.85mm thickness(D)

| Part number 1 | Part number 2 | Rated voltage [V] | Temperature characteristics | | Capacitance [F] | Capacitance tolerance [%] | tan δ [%] | HTLT | Thickness*3 [mm] | Soldering R:Reflow W:Wave |
|------------------|-------------------|-------------------|-----------------------------|------------------|-----------------|---------------------------|-----------|-------------------|------------------|---------------------------|
| | | | | | | | | Rated voltage x % | | |
| UMK212ABJ105□D-T | UMK212 BJ105□D-TD | 50 | | X5R | 1 μ | ±10, ±20 | 10 | 150 | 0.85±0.10 | R |
| UMK212BBJ225□D-T | | | | X5R | 2.2 μ | ±10, ±20 | 10 | 150 | 0.85±0.10 | R |
| TMK212 BJ474□D-T | | | B | X5R | 0.47 μ | ±10, ±20 | 3.5 | 200 | 0.85±0.10 | R |
| TMK212 BJ105□D-T | | 25 | B | X5R | 1 μ | ±10, ±20 | 5 | 200 | 0.85±0.10 | R |
| TMK212ABJ225□D-T | TMK212 BJ225□D-T | | B | X5R | 2.2 μ | ±10, ±20 | 5 | 150 | 0.85±0.10 | R |
| TMK212BBJ475□D-T | TMK212 BJ475□D-TD | | B | X5R | 4.7 μ | ±10, ±20 | 10 | 150 | 0.85±0.10 | R |
| TMK212BBJ106□D-T | | 16 | B | X5R | 10 μ | ±10, ±20 | 10 | 150 | 0.85±0.10 | R |
| EMK212 BJ105□D-T | | | B | X5R ⁺ | 1 μ | ±10, ±20 | 5 | 200 | 0.85±0.10 | R |
| EMK212ABJ225□D-T | EMK212 BJ225□D-T | | B | X5R ⁺ | 2.2 μ | ±10, ±20 | 5 | 150 | 0.85±0.10 | R |
| EMK212 BJ475□D-T | | 10 | B | X5R | 4.7 μ | ±10, ±20 | 10 | 150 | 0.85±0.10 | R |
| EMK212ABJ106□D-T | EMK212 BJ106□D-TD | | B | X5R | 10 μ | ±10, ±20 | 10 | 150 | 0.85±0.10 | R |
| LMK212 BJ105□D-T | | | B | X5R ⁺ | 1 μ | ±10, ±20 | 3.5 | 200 | 0.85±0.10 | R |
| LMK212 BJ225□D-T | | 6.3 | B | X5R ⁺ | 2.2 μ | ±10, ±20 | 5 | 200 | 0.85±0.10 | R |
| LMK212 BJ475□D-T | | | B | X5R | 4.7 μ | ±10, ±20 | 10 | 200 | 0.85±0.10 | R |
| LMK212ABJ106□D-T | LMK212 BJ106□D-T | | B | X5R | 10 μ | ±10, ±20 | 10 | 150 | 0.85±0.10 | R |
| LMK212BBJ226MD-T | | 4 | B | X5R | 2.2 μ | ±20 | 10 | 150 | 0.85±0.10 | R |
| JMK212 BJ475□D-T | | | B | X5R | 4.7 μ | ±10, ±20 | 10 | 200 | 0.85±0.10 | R |
| JMK212ABJ106□D-T | JMK212 BJ106□D-T | | B | X5R | 10 μ | ±10, ±20 | 10 | 200 | 0.85±0.10 | R |
| JMK212ABJ226MD-T | JMK212 BJ226MD-T | 4 | B | X5R | 2.2 μ | ±20 | 10 | 150 | 0.85±0.10 | R |
| AMK212BBJ476MD-T | | | B | X5R | 4.7 μ | ±20 | 10 | 150 | 0.85±0.10 | R |

[Temperature Characteristic BJ : X5R] 0.45mm thickness(K)

| Part number 1 | Part number 2 | Rated voltage [V] | Temperature characteristics | | Capacitance [F] | Capacitance tolerance [%] | tan δ [%] | HTLT | Thickness*3 [mm] | Soldering R:Reflow W:Wave |
|------------------|---------------|-------------------|-----------------------------|-----|-----------------|---------------------------|-----------|-------------------|------------------|---------------------------|
| | | | | | | | | Rated voltage x % | | |
| TMK212BBJ225□K-T | | 25 | | X5R | 2.2 μ | ±10, ±20 | 10 | 150 | 0.45±0.05 | R |
| EMK212BBJ475□K-T | | 16 | | X5R | 4.7 μ | ±10, ±20 | 10 | 150 | 0.45±0.05 | R |

▶ This catalog contains the typical specification only due to the limitation of space. When you consider the purchase of our products, please check our specification. For details of each product (characteristics graph, reliability information, precautions for use, and so on), see our Web site (<http://www.ty-top.com/>).

■ PARTS NUMBER

| Part number 1 | Part number 2 | Rated voltage [V] | Temperature characteristics | | Capacitance [F] | Capacitance tolerance [%] | tan δ [%] | HTLT | Thickness ³ [mm] | Soldering R:Reflow W:Wave |
|---------------------|------------------|-------------------|-----------------------------|--|-----------------|---------------------------|-----------|-------------------|-----------------------------|---------------------------|
| | | | | | | | | Rated voltage x % | | |
| LMK212ABJ475□K-T | LMK212 BJ475□K-T | 10 | X5R | | 4.7 μ | ±10, ±20 | 10 | 150 | 0.45±0.05 | R |
| JMK212ABJ475□K-T | JMK212 BJ475□K-T | 6.3 | X5R | | 4.7 μ | ±10, ±20 | 10 | 150 | 0.45±0.05 | R |
| JMK212ABJ106MK-T #2 | JMK212 BJ106MK-T | | X5R | | 10 μ | ±20 | 10 | 150 | 0.45±0.05 | R |

[Temperature Characteristic C6 : X6S] 1.25mm thickness (G)

| Part number 1 | Part number 2 | Rated voltage [V] | Temperature characteristics | | Capacitance [F] | Capacitance tolerance [%] | tan δ [%] | HTLT | Thickness ³ [mm] | Soldering R:Reflow W:Wave |
|------------------|---------------|-------------------|-----------------------------|--|-----------------|---------------------------|-----------|-------------------|-----------------------------|---------------------------|
| | | | | | | | | Rated voltage x % | | |
| LMK212BC6226MG-T | | 10 | X6S | | 22 μ | ±20 | 10 | 150 | 1.25+0.20/-0 | R |
| JMK212BC6226MG-T | | 6.3 | X6S | | 22 μ | ±20 | 10 | 150 | 1.25+0.20/-0 | R |
| AMK212AC6226MG-T | | 4 | X6S | | 22 μ | ±20 | 10 | 150 | 1.25+0.15/-0.05 | R |
| AMK212BC6476MG-T | | | X6S | | 47 μ | ±20 | 10 | 150 | 1.25+0.20/-0 | R |

[Temperature Characteristic C6 : X6S] 0.85mm thickness (D)

| Part number 1 | Part number 2 | Rated voltage [V] | Temperature characteristics | | Capacitance [F] | Capacitance tolerance [%] | tan δ [%] | HTLT | Thickness ³ [mm] | Soldering R:Reflow W:Wave |
|------------------|---------------|-------------------|-----------------------------|--|-----------------|---------------------------|-----------|-------------------|-----------------------------|---------------------------|
| | | | | | | | | Rated voltage x % | | |
| LMK212AC6106□D-T | | 10 | X6S | | 10 μ | ±10, ±20 | 10 | 150 | 0.85±0.10 | R |
| AMK212BC6226MD-T | | 4 | X6S | | 22 μ | ±20 | 10 | 150 | 0.85±0.10 | R |

[Temperature Characteristic B7 : X7R] 1.25mm thickness (G)

| Part number 1 | Part number 2 | Rated voltage [V] | Temperature characteristics | | Capacitance [F] | Capacitance tolerance [%] | tan δ [%] | HTLT | Thickness ³ [mm] | Soldering R:Reflow W:Wave | |
|-------------------|-------------------|-------------------|-----------------------------|-----|-----------------|---------------------------|-----------|-------------------|-----------------------------|---------------------------|-----|
| | | | | | | | | Rated voltage x % | | | |
| UMK212 B7104□G-T | | 50 | X7R | | 0.1 μ | ±10, ±20 | 3.5 | 200 | 1.25±0.10 | R/W | |
| UMK212 B7224□G-T | | | X7R | | 0.22 μ | ±10, ±20 | 3.5 | 150 | 1.25±0.10 | R/W | |
| UMK212 B7474□G-T | | | X7R | | 0.47 μ | ±10, ±20 | 3.5 | 150 | 1.25±0.10 | R/W | |
| UMK212 B7105□G-T | | | X7R | | 1 μ | ±10, ±20 | 10 | 150 | 1.25±0.10 | R/W | |
| UMK212BB7225□G-T | | | X7R | | 2.2 μ | ±10, ±20 | 10 | 150 | 1.25+0.20/-0 | R | |
| GMK212 B7105□G-T | | | 35 | X7R | | 1 μ | ±10, ±20 | 3.5 | 150 | 1.25±0.10 | R/W |
| TMK212 B7105□G-T | | 25 | X7R | | 1 μ | ±10, ±20 | 3.5 | 150 | 1.25±0.10 | R | |
| TMK212 B7225□G-TR | | | X7R | | 2.2 μ | ±10, ±20 | 10 | 150 | 1.25±0.10 | R | |
| TMK212AB7475□G-T | TMK212 B7475□G-T | | X7R | | 4.7 μ | ±10, ±20 | 10 | 150 | 1.25+0.15/-0.05 | R | |
| EMK212 B7105□G-T | | 16 | X7R | | 1 μ | ±10, ±20 | 3.5 | 200 | 1.25±0.10 | R/W | |
| EMK212 B7225□G-T | | | X7R | | 2.2 μ | ±10, ±20 | 10 | 150 | 1.25±0.10 | R | |
| EMK212 B7475□G-T | | | X7R | | 4.7 μ | ±10, ±20 | 10 | 150 | 1.25±0.10 | R | |
| EMK212BB7106MG-T | | | X7R | | 10 μ | ±20 | 10 | 150 | 1.25+0.20/-0 | R | |
| LMK212 B7105□G-T | | | 10 | X7R | | 1 μ | ±10, ±20 | 3.5 | 200 | 1.25±0.10 | R/W |
| LMK212 B7225□G-T | | | | X7R | | 2.2 μ | ±10, ±20 | 5 | 200 | 1.25±0.10 | R |
| LMK212 B7475□G-T | | X7R | | | 4.7 μ | ±10, ±20 | 10 | 150 | 1.25±0.10 | R | |
| LMK212BB7106MG-T | | X7R | | | 10 μ | ±20 | 10 | 150 | 1.25+0.20/-0 | R | |
| LMK212AB7106MG-T | LMK212 B7106MG-TD | X7R | | | 10 μ | ±20 | 10 | 150 | 1.25+0.15/-0.05 | R | |
| JMK212AB7106□G-T | JMK212 B7106□G-T | 6.3 | | X7R | | 10 μ | ±10, ±20 | 10 | 150 | 1.25+0.15/-0.05 | R |

[Temperature Characteristic B7 : X7R] 0.85mm thickness (D)

| Part number 1 | Part number 2 | Rated voltage [V] | Temperature characteristics | | Capacitance [F] | Capacitance tolerance [%] | tan δ [%] | HTLT | Thickness ³ [mm] | Soldering R:Reflow W:Wave | |
|-------------------|-------------------|-------------------|-----------------------------|-----|-----------------|---------------------------|-----------|-------------------|-----------------------------|---------------------------|-----|
| | | | | | | | | Rated voltage x % | | | |
| UMK212AB7104□D-T | | 50 | X7R | | 0.1 μ | ±10, ±20 | 10 | 150 | 0.85±0.10 | R | |
| UMK212AB7224□D-T | | | X7R | | 0.22 μ | ±10, ±20 | 10 | 150 | 0.85±0.10 | R | |
| UMK212AB7474□D-T | | | X7R | | 0.47 μ | ±10, ±20 | 10 | 150 | 0.85±0.10 | R | |
| UMK212AB7105□D-T | | | X7R | | 1 μ | ±10, ±20 | 10 | 150 | 0.85±0.10 | R | |
| TMK212AB7225□D-TR | | | 25 | X7R | | 2.2 μ | ±10, ±20 | 10 | 150 | 0.85±0.10 | R |
| EMK212 B7474□D-T | | | 16 | X7R | | 0.47 μ | ±10, ±20 | 3.5 | 200 | 0.85±0.10 | R/W |
| EMK212 B7105□D-T | | X7R | | | 1 μ | ±10, ±20 | 5 | 200 | 0.85±0.10 | R | |
| EMK212AB7225□D-T | EMK212 B7225□D-T | X7R | | | 2.2 μ | ±10, ±20 | 5 | 150 | 0.85±0.10 | R | |
| EMK212BB7475□D-T | | X7R | | | 4.7 μ | ±10, ±20 | 10 | 150 | 0.85±0.10 | R | |
| LMK212 B7105□D-T | | 10 | | X7R | | 1 μ | ±10, ±20 | 3.5 | 200 | 0.85±0.10 | R |
| LMK212AB7225□D-T | LMK212 B7225□D-T | | | X7R | | 2.2 μ | ±10, ±20 | 5 | 200 | 0.85±0.10 | R |
| LMK212AB7475□D-TR | LMK212 B7475□D-TR | | X7R | | 4.7 μ | ±10, ±20 | 10 | 150 | 0.85±0.10 | R | |

[Temperature Characteristic F : F/Y5V] 1.25mm thickness (G)

| Part number 1 | Part number 2 | Rated voltage [V] | Temperature characteristics | | Capacitance [F] | Capacitance tolerance [%] | tan δ [%] | HTLT | Thickness ³ [mm] | Soldering R:Reflow W:Wave |
|-----------------|---------------|-------------------|-----------------------------|-----|-----------------|---------------------------|-----------|-------------------|-----------------------------|---------------------------|
| | | | | | | | | Rated voltage x % | | |
| UMK212 F474ZG-T | | 50 | F | Y5V | 0.47 μ | +80/-20 | 7 | 200 | 1.25±0.10 | R/W |
| UMK212 F105ZG-T | | | F | Y5V | 1 μ | +80/-20 | 7 | 200 | 1.25±0.10 | R/W |
| EMK212 F225ZG-T | | 16 | F | Y5V | 2.2 μ | +80/-20 | 7 | 200 | 1.25±0.10 | R/W |
| LMK212 F475ZG-T | | 10 | F | Y5V | 4.7 μ | +80/-20 | 9 | 200 | 1.25±0.10 | R |
| LMK212 F106ZG-T | | | F | Y5V | 10 μ | +80/-20 | 16 | 200 | 1.25±0.10 | R |
| JMK212 F106ZG-T | | 6.3 | F | Y5V | 10 μ | +80/-20 | 16 | 200 | 1.25±0.10 | R |

[Temperature Characteristic F : F/Y5V] 0.85mm thickness (D)

| Part number 1 | Part number 2 | Rated voltage [V] | Temperature characteristics | | Capacitance [F] | Capacitance tolerance [%] | tan δ [%] | HTLT | Thickness ³ [mm] | Soldering R:Reflow W:Wave |
|-----------------|---------------|-------------------|-----------------------------|-----|-----------------|---------------------------|-----------|-------------------|-----------------------------|---------------------------|
| | | | | | | | | Rated voltage x % | | |
| UMK212 F224ZD-T | | 50 | F | Y5V | 0.22 μ | +80/-20 | 7 | 200 | 0.85±0.10 | R/W |
| LMK212 F225ZD-T | | 10 | F | Y5V | 2.2 μ | +80/-20 | 9 | 200 | 0.85±0.10 | R |
| JMK212 F475ZD-T | | 6.3 | F | Y5V | 4.7 μ | +80/-20 | 16 | 200 | 0.85±0.10 | R |

● 316TYPE

[Temperature Characteristic BJ : B/Y5R] 1.6mm thickness (L)

| Part number 1 | Part number 2 | Rated voltage [V] | Temperature characteristics | | Capacitance [F] | Capacitance tolerance [%] | tan δ [%] | HTLT | Thickness ³ [mm] | Soldering R:Reflow W:Wave | |
|------------------|---------------|-------------------|-----------------------------|------------------|------------------|---------------------------|-----------|-------------------|-----------------------------|---------------------------|---|
| | | | | | | | | Rated voltage x % | | | |
| UMK316 BJ105□L-T | | 50 | B | X5R ¹ | 1 μ | ±10, ±20 | 3.5 | 200 | 1.6±0.20 | R | |
| UMK316 BJ225□L-T | | | X5R | | 2.2 μ | ±10, ±20 | 10 | 150 | 1.6±0.20 | R | |
| UMK316 BJ475□L-T | | | X5R | | 4.7 μ | ±10, ±20 | 10 | 150 | 1.6±0.20 | R | |
| UMK316BBJ106□L-T | | | X5R | | 10 μ | ±10, ±20 | 10 | 150 | 1.6±0.30 | R | |
| TMK316 BJ225□L-T | | | 25 | B | X5R ¹ | 2.2 μ | ±10, ±20 | 3.5 | 200 | 1.6±0.20 | R |
| TMK316 BJ475□L-T | | | | B | X5R | 4.7 μ | ±10, ±20 | 5 | 150 | 1.6±0.20 | R |
| TMK316 BJ106□L-T | | X5R ¹ | | | 10 μ | ±10, ±20 | 5 | 150 | 1.6±0.20 | R | |
| TMK316BBJ226ML-T | | | X5R | | 22 μ | ±20 | 10 | 150 | 1.6±0.30 | R | |

▶ This catalog contains the typical specification only due to the limitation of space. When you consider the purchase of our products, please check our specification. For details of each product (characteristics graph, reliability information, precautions for use, and so on), see our Web site (<http://www.ty-top.com/>).

PARTS NUMBER

| Part number 1 | Part number 2 | Rated voltage [V] | Temperature characteristics | | Capacitance [F] | Capacitance tolerance [%] | tan δ [%] | HTLT | Thickness*3 [mm] | Soldering R:Reflow W:Wave |
|------------------|------------------|-------------------|-----------------------------|------------------|-----------------|---------------------------|-----------|-------------------|------------------|---------------------------|
| | | | | | | | | Rated voltage x % | | |
| EMK316 BJ225□L-T | | 16 | B | X5R ⁺ | 2.2 μ | ±10, ±20 | 3.5 | 200 | 1.6±0.20 | R/W |
| EMK316 BJ475□L-T | | | B | X5R | 4.7 μ | ±10, ±20 | 5 | 200 | 1.6±0.20 | R |
| EMK316 BJ106□L-T | | | B | X5R ⁺ | 10 μ | ±10, ±20 | 5 | 150 | 1.6±0.20 | R |
| EMK316ABJ226ML-T | EMK316 BJ226ML-T | 10 | B | X5R | 22 μ | ±20 | 10 | 150 | 1.6±0.20 | R |
| LMK316 BJ106□L-T | | | B | X5R ⁺ | 10 μ | ±10, ±20 | 5 | 200 | 1.6±0.20 | R |
| LMK316ABJ226□L-T | LMK316 BJ226□L-T | | B | X5R | 22 μ | ±10, ±20 | 10 | 150 | 1.6±0.20 | R |
| LMK316ABJ476ML-T | LMK316 BJ476ML-T | 6.3 | | X5R | 47 μ | ±20 | 10 | 200 | 1.6±0.20 | R |
| JMK316 BJ106□L-T | | | B | X5R ⁺ | 10 μ | ±10, ±20 | 5 | 200 | 1.6±0.20 | R |
| JMK316ABJ226□L-T | JMK316 BJ226□L-T | | B | X5R | 22 μ | ±10, ±20 | 10 | 200 | 1.6±0.20 | R |
| JMK316ABJ476ML-T | JMK316 BJ476ML-T | 4 | | X5R | 47 μ | ±20 | 10 | 200 | 1.6±0.20 | R |
| JMK316ABJ107ML-T | JMK316 BJ107ML-T | | | X5R | 100 μ | ±20 | 10 | 150 | 1.6±0.20 | R |
| AMK316ABJ107ML-T | AMK316 BJ107ML-T | | | X5R | 100 μ | ±20 | 10 | 150 | 1.6±0.20 | R |
| AMK316BBJ157ML-T | | 2.5 | | X5R | 150 μ | ±20 | 10 | 150 | 1.6±0.30 | R |
| PMK316BBJ227ML-T | | | | X5R | 220 μ | ±20 | 10 | 150 | 1.6±0.30 | R |

[Temperature Characteristic BJ : B/Y5R] 0.85mm thickness(D)

| Part number 1 | Part number 2 | Rated voltage [V] | Temperature characteristics | | Capacitance [F] | Capacitance tolerance [%] | tan δ [%] | HTLT | Thickness*3 [mm] | Soldering R:Reflow W:Wave |
|------------------|-------------------|-------------------|-----------------------------|------|-----------------|---------------------------|-----------|-------------------|------------------|---------------------------|
| | | | | | | | | Rated voltage x % | | |
| UMK316 BJ105□D-T | | 50 | B | X5R | 1 μ | ±10, ±20 | 3.5 | 150 | 0.85±0.10 | R |
| UMK316 BJ225□D-T | | | B | X5R | 2.2 μ | ±10, ±20 | 3.5 | 150 | 0.85±0.10 | R |
| UMK316ABJ475□D-T | UMK316 BJ475□D-T | | | X5R | 4.7 μ | ±10, ±20 | 10 | 150 | 0.85±0.10 | R |
| TMK316 BJ105□D-T | | 25 | B | X5R | 1 μ | ±10, ±20 | 3.5 | 200 | 0.85±0.10 | R |
| TMK316 BJ225□D-T | | | B | X5R | 2.2 μ | ±10, ±20 | 3.5 | 150 | 0.85±0.10 | R |
| TMK316 BJ475□D-T | | | | X5R | 4.7 μ | ±10, ±20 | 5 | 150 | 0.85±0.10 | R |
| TMK316ABJ106□D-T | TMK316 BJ106□D-TD | 16 | | X5R | 10 μ | ±10, ±20 | 10 | 150 | 0.85±0.10 | R |
| EMK316 BJ225□D-T | | | B | X5R | 2.2 μ | ±10, ±20 | 3.5 | 200 | 0.85±0.10 | R |
| EMK316 BJ475□D-T | | | B | X5R | 4.7 μ | ±10, ±20 | 5 | 200 | 0.85±0.10 | R |
| EMK316 BJ106□D-T | | 10 | | X5R | 10 μ | ±10, ±20 | 10 | 150 | 0.85±0.10 | R |
| EMK316ABJ226MD-T | EMK316 BJ226MD-T | | | X5R | 22 μ | ±20 | 10 | 150 | 0.85±0.10 | R |
| LMK316 BJ475□D-T | | | B | X5R | 4.7 μ | ±10, ±20 | 5 | 200 | 0.85±0.10 | R |
| LMK316 BJ106□D-T | | 6.3 | B | X5R | 10 μ | ±10, ±20 | 10 | 200 | 0.85±0.10 | R |
| LMK316ABJ226MD-T | LMK316 BJ226MD-T | | | X5R | 22 μ | ±20 | 10 | 150 | 0.85±0.10 | R |
| JMK316 BJ106□D-T | JMK316 BJ226MD-T | | | X5R | 22 μ | ±20 | 10 | 150 | 0.85±0.10 | R |
| JMK316ABJ226MD-T | JMK316 BJ476MD-T | | X5R | 47 μ | ±20 | 10 | 150 | 0.85±0.10 | R | |

[Temperature Characteristic C7 : X7S] 1.6mm thickness(L)

| Part number 1 | Part number 2 | Rated voltage [V] | Temperature characteristics | | Capacitance [F] | Capacitance tolerance [%] | tan δ [%] | HTLT | Thickness*3 [mm] | Soldering R:Reflow W:Wave |
|------------------|---------------|-------------------|-----------------------------|-----|-----------------|---------------------------|-----------|-------------------|------------------|---------------------------|
| | | | | | | | | Rated voltage x % | | |
| AMK316AC7476ML-T | | 4 | | X7S | 47 μ | ±20 | 10 | 150 | 1.6±0.20 | R |

[Temperature Characteristic C6 : X6S] 1.6mm thickness(L)

| Part number 1 | Part number 2 | Rated voltage [V] | Temperature characteristics | | Capacitance [F] | Capacitance tolerance [%] | tan δ [%] | HTLT | Thickness*3 [mm] | Soldering R:Reflow W:Wave |
|------------------|---------------|-------------------|-----------------------------|-----|-----------------|---------------------------|-----------|-------------------|------------------|---------------------------|
| | | | | | | | | Rated voltage x % | | |
| EMK316BC6226ML-T | | 16 | | X6S | 22 μ | ±20 | 10 | 150 | 1.6±0.30 | R |
| JMK316AC6476ML-T | | 6.3 | | X6S | 47 μ | ±20 | 10 | 150 | 1.6±0.20 | R |
| AMK316AC6476ML-T | | 4 | | X6S | 47 μ | ±20 | 10 | 200 | 1.6±0.20 | R |
| AMK316AC6107ML-T | | | | X6S | 100 μ | ±20 | 10 | 150 | 1.6±0.20 | R |

[Temperature Characteristic B7 : X7R] 1.6mm thickness(L)

| Part number 1 | Part number 2 | Rated voltage [V] | Temperature characteristics | | Capacitance [F] | Capacitance tolerance [%] | tan δ [%] | HTLT | Thickness*3 [mm] | Soldering R:Reflow W:Wave |
|-------------------|-------------------|-------------------|-----------------------------|-----|-----------------|---------------------------|-----------|-------------------|------------------|---------------------------|
| | | | | | | | | Rated voltage x % | | |
| UMK316 B7224□L-T | | 50 | | X7R | 0.22 μ | ±10, ±20 | 2.5 | 200 | 1.6±0.20 | R/W |
| UMK316 B7474□L-T | | | | X7R | 0.47 μ | ±10, ±20 | 3.5 | 200 | 1.6±0.20 | R/W |
| UMK316 B7105□L-T | | | | X7R | 1 μ | ±10, ±20 | 3.5 | 200 | 1.6±0.20 | R |
| UMK316 B7225□L-T | | 25 | | X7R | 2.2 μ | ±10, ±20 | 10 | 150 | 1.6±0.20 | R |
| UMK316AB7475□L-T | UMK316 B7475□L-T | | | X7R | 4.7 μ | ±10, ±20 | 10 | 150 | 1.6±0.20 | R |
| TMK316 B7105□L-T | | | | X7R | 1 μ | ±10, ±20 | 3.5 | 200 | 1.6±0.20 | R/W |
| TMK316 B7225□L-T | | 16 | | X7R | 2.2 μ | ±10, ±20 | 3.5 | 200 | 1.6±0.20 | R |
| TMK316AB7475□L-T | TMK316 B7475□L-T | | | X7R | 4.7 μ | ±10, ±20 | 10 | 200 | 1.6±0.20 | R |
| TMK316AB7106□L-T | TMK316 B7106□L-TD | | | X7R | 10 μ | ±10, ±20 | 10 | 150 | 1.6±0.20 | R |
| EMK316 B7225□L-T | | 10 | | X7R | 2.2 μ | ±10, ±20 | 3.5 | 200 | 1.6±0.20 | R/W |
| EMK316 B7475□L-T | | | | X7R | 4.7 μ | ±10, ±20 | 5 | 200 | 1.6±0.20 | R |
| EMK316AB7106□L-T | EMK316 B7106□L-TD | | | X7R | 10 μ | ±10, ±20 | 10 | 200 | 1.6±0.20 | R |
| EMK316BB7226ML-T | | 6.3 | | X7R | 22 μ | ±20 | 10 | 150 | 1.6±0.30 | R |
| LMK316 B7225□L-T | | | | X7R | 2.2 μ | ±10, ±20 | 3.5 | 200 | 1.6±0.20 | R/W |
| LMK316 B7475□L-T | | | | X7R | 4.7 μ | ±10, ±20 | 5 | 200 | 1.6±0.20 | R |
| LMK316AB7106□L-T | LMK316 B7106□L-TD | | | X7R | 10 μ | ±10, ±20 | 10 | 200 | 1.6±0.20 | R |
| LMK316AB7226□L-TR | LMK316 B7226□L-TD | | | X7R | 22 μ | ±10, ±20 | 10 | 150 | 1.6±0.20 | R |
| JMK316 B7106□L-T | | | | X7R | 10 μ | ±10, ±20 | 5 | 200 | 1.6±0.20 | R |

[Temperature Characteristic B7 : X7R] 0.85mm thickness(D)

| Part number 1 | Part number 2 | Rated voltage [V] | Temperature characteristics | | Capacitance [F] | Capacitance tolerance [%] | tan δ [%] | HTLT | Thickness*3 [mm] | Soldering R:Reflow W:Wave |
|------------------|---------------|-------------------|-----------------------------|-----|-----------------|---------------------------|-----------|-------------------|------------------|---------------------------|
| | | | | | | | | Rated voltage x % | | |
| UMK316 B7225□D-T | | 50 | | X7R | 2.2 μ | ±10, ±20 | 10 | 150 | 0.85±0.10 | R |
| TMK316AB7475□D-T | | 25 | | X7R | 4.7 μ | ±10, ±20 | 10 | 150 | 0.85±0.10 | R |
| LMK316AB7106MD-T | | 10 | | X7R | 10 μ | ±20 | 10 | 150 | 0.85±0.10 | R |

[Temperature Characteristic F : F/Y5V] 1.6mm thickness(L)

| Part number 1 | Part number 2 | Rated voltage [V] | Temperature characteristics | | Capacitance [F] | Capacitance tolerance [%] | tan δ [%] | HTLT | Thickness*3 [mm] | Soldering R:Reflow W:Wave |
|-----------------|---------------|-------------------|-----------------------------|-----|-----------------|---------------------------|-----------|-------------------|------------------|---------------------------|
| | | | | | | | | Rated voltage x % | | |
| GMK316 F106ZL-T | | 35 | F | Y5V | 10 μ | +80/-20 | 9 | 200 | 1.6±0.20 | R |
| TMK316 F106ZL-T | | 25 | F | Y5V | 10 μ | +80/-20 | 9 | 200 | 1.6±0.20 | R |
| EMK316 F106ZL-T | | 16 | F | Y5V | 10 μ | +80/-20 | 9 | 200 | 1.6±0.20 | R |
| LMK316 F226ZL-T | | 10 | F | Y5V | 22 μ | +80/-20 | 16 | 200 | 1.6±0.20 | R |

▶ This catalog contains the typical specification only due to the limitation of space. When you consider the purchase of our products, please check our specification. For details of each product (characteristics graph, reliability information, precautions for use, and so on), see our Web site (<http://www.ty-top.com/>).

PARTS NUMBER

[Temperature Characteristic F : F/Y5V] 1.25mm thickness(G)

| Part number 1 | Part number 2 | Rated voltage [V] | Temperature characteristics | | Capacitance [F] | Capacitance tolerance [%] | tan δ [%] | HTLT | Thickness*3 [mm] | Soldering R:Reflow W:Wave |
|-----------------|---------------|-------------------|-----------------------------|-----|-----------------|---------------------------|-----------|-------------------|------------------|---------------------------|
| | | | | | | | | Rated voltage x % | | |
| UMK316 F225ZG-T | | 50 | F | Y5V | 2.2 μ | +80/-20 | 7 | 200 | 1.25±0.10 | R/W |
| GMK316 F475ZG-T | | 35 | F | Y5V | 4.7 μ | +80/-20 | 7 | 200 | 1.25±0.10 | R |

[Temperature Characteristic F : F/Y5V] 0.85mm thickness(D)

| Part number 1 | Part number 2 | Rated voltage [V] | Temperature characteristics | | Capacitance [F] | Capacitance tolerance [%] | tan δ [%] | HTLT | Thickness*3 [mm] | Soldering R:Reflow W:Wave |
|-----------------|---------------|-------------------|-----------------------------|-----|-----------------|---------------------------|-----------|-------------------|------------------|---------------------------|
| | | | | | | | | Rated voltage x % | | |
| LMK316 F475ZD-T | | 10 | F | Y5V | 4.7 μ | +80/-20 | 9 | 200 | 0.85±0.10 | R |
| JMK316 F106ZD-T | | 6.3 | F | Y5V | 10 μ | +80/-20 | 16 | 200 | 0.85±0.10 | R |

325TYPE

[Temperature Characteristic BJ : B/X5R] 2.5mm thickness(M)

| Part number 1 | Part number 2 | Rated voltage [V] | Temperature characteristics | | Capacitance [F] | Capacitance tolerance [%] | tan δ [%] | HTLT | Thickness*3 [mm] | Soldering R:Reflow W:Wave |
|------------------|------------------|-------------------|-----------------------------|-----|-------------------|---------------------------|-----------|-------------------|------------------|---------------------------|
| | | | | | | | | Rated voltage x % | | |
| UMK325 BJ475[M-T | | 50 | | X5R | 4.7 μ | ±10, ±20 | 5 | 150 | 2.5±0.20 | R |
| UMK325 BJ106[M-T | | | | X5R | 10 μ | ±10, ±20 | 5 | 150 | 2.5±0.20 | R |
| GMK325 BJ226MM-T | | 35 | | X5R | 22 μ | ±20 | 10 | 150 | 2.5±0.20 | R |
| TMK325 BJ106[M-T | | | | B | X5R ³¹ | 10 μ | ±10, ±20 | 3.5 | 150 | 2.5±0.20 |
| TMK325 BJ226[M-T | | 25 | | X5R | 22 μ | ±10, ±20 | 5 | 150 | 2.5±0.20 | R |
| TMK325ABJ476MM-T | | | | | X5R | 47 μ | ±20 | 10 | 150 | 2.5±0.30 |
| EMK325 BJ226[M-T | | 16 | B | X5R | 22 μ | ±10, ±20 | 5 | 150 | 2.5±0.20 | R |
| EMK325 BJ476MM-T | | | | | X5R | 47 μ | ±20 | 10 | 150 | 2.5±0.20 |
| LMK325 BJ226[M-T | | 10 | B | X5R | 22 μ | ±10, ±20 | 5 | 200 | 2.5±0.20 | R |
| LMK325 BJ476MM-T | | | | | X5R | 47 μ | ±20 | 10 | 150 | 2.5±0.20 |
| LMK325ABJ107MM-T | LMK325 BJ107MM-T | 6.3 | | X5R | 100 μ | ±20 | 10 | 150 | 2.5±0.30 | R |
| JMK325 BJ476MM-T | | | | | X5R | 47 μ | ±20 | 10 | 150 | 2.5±0.20 |
| JMK325ABJ107MM-T | JMK325 BJ107MM-T | 4 | | X5R | 100 μ | ±20 | 10 | 150 | 2.5±0.30 | R |
| JMK325ABJ157MM-T | | | | | X5R | 150 μ | ±20 | 10 | 150 | 2.5±0.30 |
| JMK325ABJ227MM-T | | 4 | | X5R | 220 μ | ±20 | 10 | 150 | 2.5±0.30 | R |
| AMK325ABJ157MM-T | | | | | X5R | 150 μ | ±20 | 10 | 150 | 2.5±0.30 |
| AMK325ABJ227MM-T | | 4 | | X5R | 220 μ | ±20 | 10 | 150 | 2.5±0.30 | R |
| AMK325ABJ337MM-T | | | | | X5R | 330 μ | ±20 | 10 | 150 | 2.5±0.30 |

[Temperature Characteristic BJ : B/X5R] 1.9mm thickness(Y,N)

| Part number 1 | Part number 2 | Rated voltage [V] | Temperature characteristics | | Capacitance [F] | Capacitance tolerance [%] | tan δ [%] | HTLT | Thickness*3 [mm] | Soldering R:Reflow W:Wave |
|------------------|---------------|-------------------|-----------------------------|-------------------|-------------------|---------------------------|-----------|-------------------|------------------|---------------------------|
| | | | | | | | | Rated voltage x % | | |
| UMK325 BJ475[N-T | | 50 | | X5R | 4.7 μ | ±10, ±20 | 10 | 150 | 1.9±0.20 | R |
| GMK325 BJ225[N-T | | | | B | X5R | 2.2 μ | ±10, ±20 | 3.5 | 200 | 1.9±0.20 |
| GMK325 BJ475[N-T | | 35 | | X5R | 4.7 μ | ±10, ±20 | 10 | 150 | 1.9±0.20 | R |
| GMK325 BJ106[N-T | | | | B | X5R | 10 μ | ±10, ±20 | 5 | 150 | 1.9±0.20 |
| TMK325 BJ335MN-T | | 25 | | X5R ³¹ | 3.3 μ | ±20 | 3.5 | 200 | 1.9±0.20 | R |
| TMK325 BJ475[N-T | | | | B | X5R ³¹ | 4.7 μ | ±10, ±20 | 3.5 | 200 | 1.9±0.20 |
| TMK325 BJ106[N-T | | 16 | | X5R | 10 μ | ±10, ±20 | 5 | 200 | 1.9±0.20 | R |
| EMK325 BJ475[N-T | | | | B | X5R ³¹ | 4.7 μ | ±10, ±20 | 3.5 | 200 | 1.9±0.20 |
| EMK325 BJ106[N-T | | 10 | | X5R | 10 μ | ±10, ±20 | 3.5 | 200 | 1.9±0.20 | R |
| EMK325 BJ476MY-T | | | | | X5R | 47 μ | ±20 | 10 | 150 | 1.9±0.1/-0.2 |
| LMK325 BJ226MY-T | | 6.3 | B | X5R | 22 μ | ±20 | 5 | 150 | 1.9±0.1/-0.2 | R |
| LMK325 BJ106[N-T | | | | B | X5R | 10 μ | ±10, ±20 | 3.5 | 200 | 1.9±0.20 |
| JMK325 BJ226MY-T | | 6.3 | | X5R | 22 μ | ±20 | 5 | 200 | 1.9±0.1/-0.2 | R |
| JMK325 BJ107MY-T | | | | | X5R | 100 μ | ±20 | 10 | 150 | 1.9±0.1/-0.2 |
| JMK325 BJ476MN-T | | | | X5R | 47 μ | ±20 | 10 | 150 | 1.9±0.20 | R |

[Temperature Characteristic BJ : B/X5R] 0.85mm thickness(D)

| Part number 1 | Part number 2 | Rated voltage [V] | Temperature characteristics | | Capacitance [F] | Capacitance tolerance [%] | tan δ [%] | HTLT | Thickness*3 [mm] | Soldering R:Reflow W:Wave |
|------------------|---------------|-------------------|-----------------------------|-----|-----------------|---------------------------|-----------|-------------------|------------------|---------------------------|
| | | | | | | | | Rated voltage x % | | |
| TMK325 BJ106[D-T | | 25 | B | X5R | 10 μ | ±10, ±20 | 5 | 150 | 0.85±0.10 | R |
| EMK325 BJ106[D-T | | | | B | X5R | 10 μ | ±10, ±20 | 5 | 150 | 0.85±0.10 |
| EMK325 BJ226MD-T | | 16 | B | X5R | 22 μ | ±20 | 10 | 150 | 0.85±0.10 | R |
| LMK325 BJ335[D-T | | | | B | X5R | 3.3 μ | ±10, ±20 | 3.5 | 200 | 0.85±0.10 |
| LMK325 BJ475[D-T | | 10 | B | X5R | 4.7 μ | ±10, ±20 | 5 | 200 | 0.85±0.10 | R |
| LMK325 BJ106[D-T | | | | B | X5R | 10 μ | ±10, ±20 | 5 | 150 | 0.85±0.10 |

[Temperature Characteristic C7 : X7S] 2.5mm thickness(M)

| Part number 1 | Part number 2 | Rated voltage [V] | Temperature characteristics | | Capacitance [F] | Capacitance tolerance [%] | tan δ [%] | HTLT | Thickness*3 [mm] | Soldering R:Reflow W:Wave |
|------------------|---------------|-------------------|-----------------------------|-----|-----------------|---------------------------|-----------|-------------------|------------------|---------------------------|
| | | | | | | | | Rated voltage x % | | |
| JMK325AC7107MM-T | | 6.3 | | X7S | 100 μ | ±20 | 10 | 150 | 2.5±0.30 | R |

[Temperature Characteristic C6 : X6S] 2.5mm thickness(M)

| Part number 1 | Part number 2 | Rated voltage [V] | Temperature characteristics | | Capacitance [F] | Capacitance tolerance [%] | tan δ [%] | HTLT | Thickness*3 [mm] | Soldering R:Reflow W:Wave |
|------------------|---------------|-------------------|-----------------------------|-----|-----------------|---------------------------|-----------|-------------------|------------------|---------------------------|
| | | | | | | | | Rated voltage x % | | |
| EMK325AC6476MM-T | | 16 | | X6S | 47 μ | ±20 | 10 | 150 | 2.5±0.30 | R |
| JMK325AC6107MM-T | | | | | X6S | 100 μ | ±20 | 10 | 150 | 2.5±0.30 |
| AMK325AC6157MM-T | | 4 | | X6S | 150 μ | ±20 | 10 | 150 | 2.5±0.30 | R |
| AMK325AC6227MM-T | | | | | X6S | 220 μ | ±20 | 10 | 150 | 2.5±0.30 |
| PMK325AC6337MM-T | | 2.5 | | X6S | 330 μ | ±20 | 10 | 150 | 2.5±0.30 | R |

[Temperature Characteristic B7 : X7R] 2.5mm thickness(M)

| Part number 1 | Part number 2 | Rated voltage [V] | Temperature characteristics | | Capacitance [F] | Capacitance tolerance [%] | tan δ [%] | HTLT | Thickness*3 [mm] | Soldering R:Reflow W:Wave |
|-------------------|---------------|-------------------|-----------------------------|-----|-----------------|---------------------------|-----------|-------------------|------------------|---------------------------|
| | | | | | | | | Rated voltage x % | | |
| UMK325 B7475[M-T | | 50 | | X7R | 4.7 μ | ±10, ±20 | 5 | 150 | 2.5±0.20 | R |
| UMK325AB7106[M-T | | | | | X7R | 10 μ | ±10, ±20 | 10 | 150 | 2.5±0.30 |
| TMK325AB7106[M-T | | 25 | | X7R | 10 μ | ±10, ±20 | 10 | 150 | 2.5±0.30 | R |
| TMK325 B7226[M-TR | | | | | X7R | 22 μ | ±10, ±20 | 10 | 150 | 2.5±0.20 |
| EMK325 B7226[M-TR | | 16 | | X7R | 22 μ | ±10, ±20 | 10 | 150 | 2.5±0.20 | R |
| LMK325 B7476[M-TR | | 10 | | X7R | 47 μ | ±10, ±20 | 10 | 150 | 2.5±0.20 | R |
| JMK325 B7476[M-TR | | 6.3 | | X7R | 47 μ | ±10, ±20 | 10 | 200 | 2.5±0.20 | R |

► This catalog contains the typical specification only due to the limitation of space. When you consider the purchase of our products, please check our specification. For details of each product (characteristics graph, reliability information, precautions for use, and so on), see our Web site (<http://www.ty-top.com/>).

PARTS NUMBER

[Temperature Characteristic B7 : X7R] 1.9mm thickness(N)

| Part number 1 | Part number 2 | Rated voltage [V] | Temperature characteristics | | Capacitance [F] | Capacitance tolerance [%] | tan δ [%] | HTLT | Thickness*3 [mm] | Soldering R:Reflow W:Wave |
|-------------------|---------------|-------------------|-----------------------------|-----|-----------------|---------------------------|-----------|-------------------|------------------|---------------------------|
| | | | | | | | | Rated voltage x % | | |
| UMK325 B7475□N-TR | | 50 | | X7R | 4.7 μ | ±10, ±20 | 10 | 150 | 1.9±0.20 | R |
| TMK325 B7335□N-T | | 25 | | X7R | 3.3 μ | ±10, ±20 | 3.5 | 200 | 1.9±0.20 | R |
| TMK325 B7475□N-T | | | | X7R | 4.7 μ | ±10, ±20 | 3.5 | 150 | 1.9±0.20 | R |
| TMK325 B7106□N-TR | | | | X7R | 10 μ | ±10, ±20 | 10 | 150 | 1.9±0.20 | R |
| EMK325 B7475□N-T | | | | X7R | 4.7 μ | ±10, ±20 | 3.5 | 200 | 1.9±0.20 | R |
| EMK325 B7106□N-T | | 16 | | X7R | 10 μ | ±10, ±20 | 3.5 | 150 | 1.9±0.20 | R |
| LMK325 B7106□N-T | | 10 | | X7R | 10 μ | ±10, ±20 | 3.5 | 200 | 1.9±0.20 | R |

[Temperature Characteristic F : F/Y5V] 1.9mm thickness(N)

| Part number 1 | Part number 2 | Rated voltage [V] | Temperature characteristics | | Capacitance [F] | Capacitance tolerance [%] | tan δ [%] | HTLT | Thickness*3 [mm] | Soldering R:Reflow W:Wave |
|-----------------|---------------|-------------------|-----------------------------|-----|-----------------|---------------------------|-----------|-------------------|------------------|---------------------------|
| | | | | | | | | Rated voltage x % | | |
| EMK325 F226ZN-T | | 16 | F | Y5V | 22 μ | +80/-20 | 16 | 200 | 1.9±0.20 | R |
| LMK325 F226ZN-T | | 10 | F | Y5V | 22 μ | +80/-20 | 16 | 200 | 1.9±0.20 | R |
| JMK325 F476ZN-T | | 6.3 | F | Y5V | 47 μ | +80/-20 | 16 | 200 | 1.9±0.20 | R |

Multilayer Ceramic Capacitors(Temperature compensating type)

● 042 TYPE

[Temperature Characteristic CG : CG/C0G] 0.2mm thickness(C,D)

| Part number 1 | Part number 2 | Rated voltage [V] | Temperature characteristics | | Capacitance [F] | Capacitance tolerance [%] | Q (at 1MHz) min | HTLT | Thickness*3 [mm] | Soldering R:Reflow W:Wave |
|------------------|---------------|-------------------|-----------------------------|-------|-----------------|---------------------------|-----------------|-------------------|------------------|---------------------------|
| | | | | | | | | Rated voltage x % | | |
| EMK042 CG0R4□D-W | | 16 | CG | C0G | 0.4 p | ±0.1pF, ±0.25pF | 408 | 200 | 0.2±0.02 | R |
| EMK042 CG0R5□D-W | | | CG | C0G | 0.5 p | ±0.1pF, ±0.25pF | 410 | 200 | 0.2±0.02 | R |
| EMK042 CG0R6□D-W | | | CG | C0G | 0.6 p | ±0.1pF, ±0.25pF | 412 | 200 | 0.2±0.02 | R |
| EMK042 CG0R7□D-W | | | CG | C0G | 0.7 p | ±0.1pF, ±0.25pF | 414 | 200 | 0.2±0.02 | R |
| EMK042 CGR75□D-W | | | CG | C0G | 0.75 p | ±0.1pF, ±0.25pF | 415 | 200 | 0.2±0.02 | R |
| EMK042 CG0R8□D-W | | | CG | C0G | 0.8 p | ±0.1pF, ±0.25pF | 416 | 200 | 0.2±0.02 | R |
| EMK042 CG0R9□D-W | | | CG | C0G | 0.9 p | ±0.1pF, ±0.25pF | 418 | 200 | 0.2±0.02 | R |
| EMK042 CG010□D-W | | | CG | C0G | 1 p | ±0.1pF, ±0.25pF | 420 | 200 | 0.2±0.02 | R |
| EMK042 CG1R1□D-W | | | CG | C0G | 1.1 p | ±0.1pF, ±0.25pF | 422 | 200 | 0.2±0.02 | R |
| EMK042 CG1R2□D-W | | | CG | C0G | 1.2 p | ±0.1pF, ±0.25pF | 424 | 200 | 0.2±0.02 | R |
| EMK042 CG1R3□D-W | | | CG | C0G | 1.3 p | ±0.1pF, ±0.25pF | 426 | 200 | 0.2±0.02 | R |
| EMK042 CG1R4□D-W | | | CG | C0G | 1.4 p | ±0.1pF, ±0.25pF | 428 | 200 | 0.2±0.02 | R |
| EMK042 CG1R5□D-W | | | CG | C0G | 1.5 p | ±0.1pF, ±0.25pF | 430 | 200 | 0.2±0.02 | R |
| EMK042 CG1R6□D-W | | | CG | C0G | 1.6 p | ±0.1pF, ±0.25pF | 432 | 200 | 0.2±0.02 | R |
| EMK042 CG1R7□D-W | | | CG | C0G | 1.7 p | ±0.1pF, ±0.25pF | 434 | 200 | 0.2±0.02 | R |
| EMK042 CG1R8□D-W | | | CG | C0G | 1.8 p | ±0.1pF, ±0.25pF | 436 | 200 | 0.2±0.02 | R |
| EMK042 CG1R9□D-W | | | CG | C0G | 1.9 p | ±0.1pF, ±0.25pF | 438 | 200 | 0.2±0.02 | R |
| EMK042 CG020□D-W | | | CG | C0G | 2 p | ±0.1pF, ±0.25pF | 440 | 200 | 0.2±0.02 | R |
| EMK042 CG2R1□D-W | | | CG | C0G | 2.1 p | ±0.1pF, ±0.25pF | 442 | 200 | 0.2±0.02 | R |
| EMK042 CG2R2□D-W | | | CG | C0G | 2.2 p | ±0.1pF, ±0.25pF | 444 | 200 | 0.2±0.02 | R |
| EMK042 CG2R3□D-W | | | CG | C0G | 2.3 p | ±0.1pF, ±0.25pF | 446 | 200 | 0.2±0.02 | R |
| EMK042 CG2R4□D-W | | | CG | C0G | 2.4 p | ±0.1pF, ±0.25pF | 448 | 200 | 0.2±0.02 | R |
| EMK042 CG2R5□D-W | | | CG | C0G | 2.5 p | ±0.1pF, ±0.25pF | 450 | 200 | 0.2±0.02 | R |
| EMK042 CG2R6□D-W | | | CG | C0G | 2.6 p | ±0.1pF, ±0.25pF | 452 | 200 | 0.2±0.02 | R |
| EMK042 CG2R7□D-W | | | CG | C0G | 2.7 p | ±0.1pF, ±0.25pF | 454 | 200 | 0.2±0.02 | R |
| EMK042 CG2R8□D-W | | | CG | C0G | 2.8 p | ±0.1pF, ±0.25pF | 456 | 200 | 0.2±0.02 | R |
| EMK042 CG2R9□D-W | | | CG | C0G | 2.9 p | ±0.1pF, ±0.25pF | 458 | 200 | 0.2±0.02 | R |
| EMK042 CG030□D-W | | | CG | C0G | 3 p | ±0.1pF, ±0.25pF | 460 | 200 | 0.2±0.02 | R |
| EMK042 CG3R1□D-W | | | CG | C0G | 3.1 p | ±0.1pF, ±0.25pF | 462 | 200 | 0.2±0.02 | R |
| EMK042 CG3R2□D-W | | | CG | C0G | 3.2 p | ±0.1pF, ±0.25pF | 464 | 200 | 0.2±0.02 | R |
| EMK042 CG3R3□D-W | | | CG | C0G | 3.3 p | ±0.1pF, ±0.25pF | 466 | 200 | 0.2±0.02 | R |
| EMK042 CG3R4□D-W | | | CG | C0G | 3.4 p | ±0.1pF, ±0.25pF | 468 | 200 | 0.2±0.02 | R |
| EMK042 CG3R5□D-W | | | CG | C0G | 3.5 p | ±0.1pF, ±0.25pF | 470 | 200 | 0.2±0.02 | R |
| EMK042 CG3R6□D-W | | | CG | C0G | 3.6 p | ±0.1pF, ±0.25pF | 472 | 200 | 0.2±0.02 | R |
| EMK042 CG3R7□D-W | | | CG | C0G | 3.7 p | ±0.1pF, ±0.25pF | 474 | 200 | 0.2±0.02 | R |
| EMK042 CG3R8□D-W | | | CG | C0G | 3.8 p | ±0.1pF, ±0.25pF | 476 | 200 | 0.2±0.02 | R |
| EMK042 CG3R9□D-W | | | CG | C0G | 3.9 p | ±0.1pF, ±0.25pF | 478 | 200 | 0.2±0.02 | R |
| EMK042 CG040□D-W | | | CG | C0G | 4 p | ±0.1pF, ±0.25pF | 480 | 200 | 0.2±0.02 | R |
| EMK042 CG4R1□D-W | | | CG | C0G | 4.1 p | ±0.1pF, ±0.25pF | 482 | 200 | 0.2±0.02 | R |
| EMK042 CG4R2□D-W | | | CG | C0G | 4.2 p | ±0.1pF, ±0.25pF | 484 | 200 | 0.2±0.02 | R |
| EMK042 CG4R3□D-W | | | CG | C0G | 4.3 p | ±0.1pF, ±0.25pF | 486 | 200 | 0.2±0.02 | R |
| EMK042 CG4R4□D-W | | | CG | C0G | 4.4 p | ±0.1pF, ±0.25pF | 488 | 200 | 0.2±0.02 | R |
| EMK042 CG4R5□D-W | | | CG | C0G | 4.5 p | ±0.1pF, ±0.25pF | 490 | 200 | 0.2±0.02 | R |
| EMK042 CG4R6□D-W | | | CG | C0G | 4.6 p | ±0.1pF, ±0.25pF | 492 | 200 | 0.2±0.02 | R |
| EMK042 CG4R7□D-W | | | CG | C0G | 4.7 p | ±0.1pF, ±0.25pF | 494 | 200 | 0.2±0.02 | R |
| EMK042 CG4R8□D-W | | | CG | C0G | 4.8 p | ±0.1pF, ±0.25pF | 496 | 200 | 0.2±0.02 | R |
| EMK042 CG4R9□D-W | | | CG | C0G | 4.9 p | ±0.1pF, ±0.25pF | 498 | 200 | 0.2±0.02 | R |
| EMK042 CG050□D-W | | | CG | C0G | 5 p | ±0.1pF, ±0.25pF | 500 | 200 | 0.2±0.02 | R |
| EMK042 CG5R1DD-W | | | CG | C0G | 5.1 p | ±0.5pF | 502 | 200 | 0.2±0.02 | R |
| EMK042 CG5R2DD-W | | | CG | C0G | 5.2 p | ±0.5pF | 504 | 200 | 0.2±0.02 | R |
| EMK042 CG5R3DD-W | | CG | C0G | 5.3 p | ±0.5pF | 506 | 200 | 0.2±0.02 | R | |
| EMK042 CG5R4DD-W | | CG | C0G | 5.4 p | ±0.5pF | 508 | 200 | 0.2±0.02 | R | |
| EMK042 CG5R5DD-W | | CG | C0G | 5.5 p | ±0.5pF | 510 | 200 | 0.2±0.02 | R | |
| EMK042 CG5R6DD-W | | CG | C0G | 5.6 p | ±0.5pF | 512 | 200 | 0.2±0.02 | R | |
| EMK042 CG5R7DD-W | | CG | C0G | 5.7 p | ±0.5pF | 514 | 200 | 0.2±0.02 | R | |
| EMK042 CG5R8DD-W | | CG | C0G | 5.8 p | ±0.5pF | 516 | 200 | 0.2±0.02 | R | |
| EMK042 CG5R9DD-W | | CG | C0G | 5.9 p | ±0.5pF | 518 | 200 | 0.2±0.02 | R | |
| EMK042 CG060DD-W | | CG | C0G | 6 p | ±0.5pF | 520 | 200 | 0.2±0.02 | R | |
| EMK042 CG6R1DD-W | | CG | C0G | 6.1 p | ±0.5pF | 522 | 200 | 0.2±0.02 | R | |
| EMK042 CG6R2DD-W | | CG | C0G | 6.2 p | ±0.5pF | 524 | 200 | 0.2±0.02 | R | |
| EMK042 CG6R3DD-W | | CG | C0G | 6.3 p | ±0.5pF | 526 | 200 | 0.2±0.02 | R | |
| EMK042 CG6R4DD-W | | CG | C0G | 6.4 p | ±0.5pF | 528 | 200 | 0.2±0.02 | R | |
| EMK042 CG6R5DD-W | | CG | C0G | 6.5 p | ±0.5pF | 530 | 200 | 0.2±0.02 | R | |
| EMK042 CG6R6DD-W | | CG | C0G | 6.6 p | ±0.5pF | 532 | 200 | 0.2±0.02 | R | |
| EMK042 CG6R7DD-W | | CG | C0G | 6.7 p | ±0.5pF | 534 | 200 | 0.2±0.02 | R | |
| EMK042 CG6R8DD-W | | CG | C0G | 6.8 p | ±0.5pF | 536 | 200 | 0.2±0.02 | R | |
| EMK042 CG6R9DD-W | | CG | C0G | 6.9 p | ±0.5pF | 538 | 200 | 0.2±0.02 | R | |

▶ This catalog contains the typical specification only due to the limitation of space. When you consider the purchase of our products, please check our specification. For details of each product (characteristics graph, reliability information, precautions for use, and so on), see our Web site (<http://www.ty-top.com/>).

| Part number 1 | Part number 2 | Rated voltage [V] | Temperature characteristics | | Capacitance [F] | Capacitance tolerance [%] | Q (at 1MHz) min | HTLT | Thickness*3 [mm] | Soldering R,Reflow W,Wave |
|------------------|---------------|-------------------|-----------------------------|-----|-----------------|---------------------------|-----------------|-------------------|------------------|---------------------------|
| | | | | | | | | Rated voltage x % | | |
| EMK042 CG070DD-W | | | CG | C0G | 7 p | ±0.5pF | 540 | 200 | 0.2±0.02 | R |
| EMK042 CG7R1DD-W | | | CG | C0G | 7.1 p | ±0.5pF | 542 | 200 | 0.2±0.02 | R |
| EMK042 CG7R2DD-W | | | CG | C0G | 7.2 p | ±0.5pF | 544 | 200 | 0.2±0.02 | R |
| EMK042 CG7R3DD-W | | | CG | C0G | 7.3 p | ±0.5pF | 546 | 200 | 0.2±0.02 | R |
| EMK042 CG7R4DD-W | | | CG | C0G | 7.4 p | ±0.5pF | 548 | 200 | 0.2±0.02 | R |
| EMK042 CG7R5DD-W | | | CG | C0G | 7.5 p | ±0.5pF | 550 | 200 | 0.2±0.02 | R |
| EMK042 CG7R6DD-W | | | CG | C0G | 7.6 p | ±0.5pF | 552 | 200 | 0.2±0.02 | R |
| EMK042 CG7R7DD-W | | | CG | C0G | 7.7 p | ±0.5pF | 554 | 200 | 0.2±0.02 | R |
| EMK042 CG7R8DD-W | | | CG | C0G | 7.8 p | ±0.5pF | 556 | 200 | 0.2±0.02 | R |
| EMK042 CG7R9DD-W | | | CG | C0G | 7.9 p | ±0.5pF | 558 | 200 | 0.2±0.02 | R |
| EMK042 CG080DD-W | | | CG | C0G | 8 p | ±0.5pF | 560 | 200 | 0.2±0.02 | R |
| EMK042 CG8R1DD-W | | | CG | C0G | 8.1 p | ±0.5pF | 562 | 200 | 0.2±0.02 | R |
| EMK042 CG8R2DD-W | | | CG | C0G | 8.2 p | ±0.5pF | 564 | 200 | 0.2±0.02 | R |
| EMK042 CG8R3DD-W | | | CG | C0G | 8.3 p | ±0.5pF | 566 | 200 | 0.2±0.02 | R |
| EMK042 CG8R4DD-W | | | CG | C0G | 8.4 p | ±0.5pF | 568 | 200 | 0.2±0.02 | R |
| EMK042 CG8R5DD-W | | | CG | C0G | 8.5 p | ±0.5pF | 570 | 200 | 0.2±0.02 | R |
| EMK042 CG8R6DD-W | | | CG | C0G | 8.6 p | ±0.5pF | 572 | 200 | 0.2±0.02 | R |
| EMK042 CG8R7DD-W | | | CG | C0G | 8.7 p | ±0.5pF | 574 | 200 | 0.2±0.02 | R |
| EMK042 CG8R8DD-W | | | CG | C0G | 8.8 p | ±0.5pF | 576 | 200 | 0.2±0.02 | R |
| EMK042 CG8R9DD-W | | | CG | C0G | 8.9 p | ±0.5pF | 578 | 200 | 0.2±0.02 | R |
| EMK042 CG090DD-W | | | CG | C0G | 9 p | ±0.5pF | 580 | 200 | 0.2±0.02 | R |
| EMK042 CG9R1DD-W | | | CG | C0G | 9.1 p | ±0.5pF | 582 | 200 | 0.2±0.02 | R |
| EMK042 CG9R2DD-W | | | CG | C0G | 9.2 p | ±0.5pF | 584 | 200 | 0.2±0.02 | R |
| EMK042 CG9R3DD-W | | | CG | C0G | 9.3 p | ±0.5pF | 586 | 200 | 0.2±0.02 | R |
| EMK042 CG9R4DD-W | | | CG | C0G | 9.4 p | ±0.5pF | 588 | 200 | 0.2±0.02 | R |
| EMK042 CG9R5DD-W | | | CG | C0G | 9.5 p | ±0.5pF | 590 | 200 | 0.2±0.02 | R |
| EMK042 CG9R6DD-W | | | CG | C0G | 9.6 p | ±0.5pF | 592 | 200 | 0.2±0.02 | R |
| EMK042 CG9R7DD-W | | | CG | C0G | 9.7 p | ±0.5pF | 594 | 200 | 0.2±0.02 | R |
| EMK042 CG9R8DD-W | | | CG | C0G | 9.8 p | ±0.5pF | 596 | 200 | 0.2±0.02 | R |
| EMK042 CG9R9DD-W | | | CG | C0G | 9.9 p | ±0.5pF | 598 | 200 | 0.2±0.02 | R |
| EMK042 CG100DD-W | | | CG | C0G | 10 p | ±0.5pF | 600 | 200 | 0.2±0.02 | R |
| EMK042 CG110JD-W | | | CG | C0G | 11 p | ±5% | 620 | 200 | 0.2±0.02 | R |
| EMK042 CG120JD-W | | | CG | C0G | 12 p | ±5% | 640 | 200 | 0.2±0.02 | R |
| EMK042 CG130JD-W | | | CG | C0G | 13 p | ±5% | 660 | 200 | 0.2±0.02 | R |
| EMK042 CG150JD-W | | | CG | C0G | 15 p | ±5% | 700 | 200 | 0.2±0.02 | R |
| EMK042 CG160JC-W | | | CG | C0G | 16 p | ±5% | 720 | 200 | 0.2±0.02 | R |
| EMK042 CG180JC-W | | | CG | C0G | 18 p | ±5% | 760 | 200 | 0.2±0.02 | R |
| EMK042 CG200JC-W | | | CG | C0G | 20 p | ±5% | 800 | 200 | 0.2±0.02 | R |
| EMK042 CG220JC-W | | | CG | C0G | 22 p | ±5% | 840 | 200 | 0.2±0.02 | R |
| EMK042 CG240JC-W | | | CG | C0G | 24 p | ±5% | 880 | 200 | 0.2±0.02 | R |
| EMK042 CG270JC-W | | | CG | C0G | 27 p | ±5% | 940 | 200 | 0.2±0.02 | R |
| EMK042 CG300JC-W | | | CG | C0G | 30 p | ±5% | 1000 | 200 | 0.2±0.02 | R |
| EMK042 CG330JC-W | | | CG | C0G | 33 p | ±5% | 1000 | 200 | 0.2±0.02 | R |
| EMK042 CG360JC-W | | | CG | C0G | 36 p | ±5% | 1000 | 200 | 0.2±0.02 | R |
| EMK042 CG390JC-W | | | CG | C0G | 39 p | ±5% | 1000 | 200 | 0.2±0.02 | R |
| EMK042 CG430JC-W | | | CG | C0G | 43 p | ±5% | 1000 | 200 | 0.2±0.02 | R |
| EMK042 CG470JC-W | | | CG | C0G | 47 p | ±5% | 1000 | 200 | 0.2±0.02 | R |
| EMK042 CG510JC-W | | | CG | C0G | 51 p | ±5% | 1000 | 200 | 0.2±0.02 | R |
| EMK042 CG560JC-W | | | CG | C0G | 56 p | ±5% | 1000 | 200 | 0.2±0.02 | R |
| EMK042 CG620JC-W | | | CG | C0G | 62 p | ±5% | 1000 | 200 | 0.2±0.02 | R |
| EMK042 CG680JC-W | | | CG | C0G | 68 p | ±5% | 1000 | 200 | 0.2±0.02 | R |
| EMK042 CG750JC-W | | | CG | C0G | 75 p | ±5% | 1000 | 200 | 0.2±0.02 | R |
| EMK042 CG820JC-W | | | CG | C0G | 82 p | ±5% | 1000 | 200 | 0.2±0.02 | R |
| EMK042 CG910JC-W | | | CG | C0G | 91 p | ±5% | 1000 | 200 | 0.2±0.02 | R |
| EMK042 CG101JC-W | | | CG | C0G | 100 p | ±5% | 1000 | 200 | 0.2±0.02 | R |

[Temperature Characteristic ΔC : CΔ/C0Δ] 0.2mm thickness (C,D)

| Part number 1 | Part number 2 | Rated voltage [V] | Temperature characteristics | | Capacitance [F] | Capacitance tolerance [%] | Q (at 1MHz) min | HTLT | Thickness*3 [mm] | Soldering R,Reflow W,Wave |
|------------------|---------------|-------------------|-----------------------------|-----|-----------------|---------------------------|-----------------|-------------------|------------------|---------------------------|
| | | | | | | | | Rated voltage x % | | |
| EMK042 CK0R4□D-W | | | CK | C0K | 0.4 p | ±0.1pF, ±0.25pF | 408 | 200 | 0.2±0.02 | R |
| EMK042 CK0R5□D-W | | | CK | C0K | 0.5 p | ±0.1pF, ±0.25pF | 410 | 200 | 0.2±0.02 | R |
| EMK042 CK0R6□D-W | | | CK | C0K | 0.6 p | ±0.1pF, ±0.25pF | 412 | 200 | 0.2±0.02 | R |
| EMK042 CK0R7□D-W | | | CK | C0K | 0.7 p | ±0.1pF, ±0.25pF | 414 | 200 | 0.2±0.02 | R |
| EMK042 CKR75□D-W | | | CK | C0K | 0.75 p | ±0.1pF, ±0.25pF | 415 | 200 | 0.2±0.02 | R |
| EMK042 CK0R8□D-W | | | CK | C0K | 0.8 p | ±0.1pF, ±0.25pF | 416 | 200 | 0.2±0.02 | R |
| EMK042 CK0R9□D-W | | | CK | C0K | 0.9 p | ±0.1pF, ±0.25pF | 418 | 200 | 0.2±0.02 | R |
| EMK042 CK010□D-W | | | CK | C0K | 1 p | ±0.1pF, ±0.25pF | 420 | 200 | 0.2±0.02 | R |
| EMK042 CK1R1□D-W | | | CK | C0K | 1.1 p | ±0.1pF, ±0.25pF | 422 | 200 | 0.2±0.02 | R |
| EMK042 CK1R2□D-W | | | CK | C0K | 1.2 p | ±0.1pF, ±0.25pF | 424 | 200 | 0.2±0.02 | R |
| EMK042 CK1R3□D-W | | | CK | C0K | 1.3 p | ±0.1pF, ±0.25pF | 426 | 200 | 0.2±0.02 | R |
| EMK042 CK1R4□D-W | | | CK | C0K | 1.4 p | ±0.1pF, ±0.25pF | 428 | 200 | 0.2±0.02 | R |
| EMK042 CK1R5□D-W | | | CK | C0K | 1.5 p | ±0.1pF, ±0.25pF | 430 | 200 | 0.2±0.02 | R |
| EMK042 CK1R6□D-W | | | CK | C0K | 1.6 p | ±0.1pF, ±0.25pF | 432 | 200 | 0.2±0.02 | R |
| EMK042 CK1R7□D-W | | | CK | C0K | 1.7 p | ±0.1pF, ±0.25pF | 434 | 200 | 0.2±0.02 | R |
| EMK042 CK1R8□D-W | | | CK | C0K | 1.8 p | ±0.1pF, ±0.25pF | 436 | 200 | 0.2±0.02 | R |
| EMK042 CK1R9□D-W | | | CK | C0K | 1.9 p | ±0.1pF, ±0.25pF | 438 | 200 | 0.2±0.02 | R |
| EMK042 CK020□D-W | | | CK | C0K | 2 p | ±0.1pF, ±0.25pF | 440 | 200 | 0.2±0.02 | R |
| EMK042 CK2R1□D-W | | | CK | C0K | 2.1 p | ±0.1pF, ±0.25pF | 442 | 200 | 0.2±0.02 | R |
| EMK042 CK2R2□D-W | | | CK | C0K | 2.2 p | ±0.1pF, ±0.25pF | 444 | 200 | 0.2±0.02 | R |
| EMK042 CK2R3□D-W | | | CK | C0K | 2.3 p | ±0.1pF, ±0.25pF | 446 | 200 | 0.2±0.02 | R |
| EMK042 CK2R4□D-W | | | CK | C0K | 2.4 p | ±0.1pF, ±0.25pF | 448 | 200 | 0.2±0.02 | R |
| EMK042 CK2R5□D-W | | | CK | C0K | 2.5 p | ±0.1pF, ±0.25pF | 450 | 200 | 0.2±0.02 | R |
| EMK042 CK2R6□D-W | | | CK | C0K | 2.6 p | ±0.1pF, ±0.25pF | 452 | 200 | 0.2±0.02 | R |
| EMK042 CK2R7□D-W | | | CK | C0K | 2.7 p | ±0.1pF, ±0.25pF | 454 | 200 | 0.2±0.02 | R |
| EMK042 CK2R8□D-W | | | CK | C0K | 2.8 p | ±0.1pF, ±0.25pF | 456 | 200 | 0.2±0.02 | R |
| EMK042 CK2R9□D-W | | | CK | C0K | 2.9 p | ±0.1pF, ±0.25pF | 458 | 200 | 0.2±0.02 | R |
| EMK042 CJ030□D-W | | | CJ | C0J | 3 p | ±0.1pF, ±0.25pF | 460 | 200 | 0.2±0.02 | R |
| EMK042 CJ3R1□D-W | | | CJ | C0J | 3.1 p | ±0.1pF, ±0.25pF | 462 | 200 | 0.2±0.02 | R |
| EMK042 CJ3R2□D-W | | | CJ | C0J | 3.2 p | ±0.1pF, ±0.25pF | 464 | 200 | 0.2±0.02 | R |
| EMK042 CJ3R3□D-W | | | CJ | C0J | 3.3 p | ±0.1pF, ±0.25pF | 466 | 200 | 0.2±0.02 | R |

▶ This catalog contains the typical specification only due to the limitation of space. When you consider the purchase of our products, please check our specification. For details of each product (characteristics graph, reliability information, precautions for use, and so on), see our Web site (<http://www.ty-top.com/>).

| Part number 1 | Part number 2 | Rated voltage [V] | Temperature characteristics | | Capacitance [F] | Capacitance tolerance [%] | Q (at 1MHz) min | HTLT | Thickness*3 [mm] | Soldering R:Reflow W:Wave |
|------------------|---------------|-------------------|-----------------------------|-----|-----------------|---------------------------|-----------------|-------------------|------------------|---------------------------|
| | | | | | | | | Rated voltage x % | | |
| EMK042 CJ3R4[D-W | | | CJ | C0J | 3.4 p | ±0.1pF, ±0.25pF | 468 | 200 | 0.2±0.02 | R |
| EMK042 CJ3R5[D-W | | | CJ | C0J | 3.5 p | ±0.1pF, ±0.25pF | 470 | 200 | 0.2±0.02 | R |
| EMK042 CJ3R6[D-W | | | CJ | C0J | 3.6 p | ±0.1pF, ±0.25pF | 472 | 200 | 0.2±0.02 | R |
| EMK042 CJ3R7[D-W | | | CJ | C0J | 3.7 p | ±0.1pF, ±0.25pF | 474 | 200 | 0.2±0.02 | R |
| EMK042 CJ3R8[D-W | | | CJ | C0J | 3.8 p | ±0.1pF, ±0.25pF | 476 | 200 | 0.2±0.02 | R |
| EMK042 CJ3R9[D-W | | | CJ | C0J | 3.9 p | ±0.1pF, ±0.25pF | 478 | 200 | 0.2±0.02 | R |
| EMK042 CH040[D-W | | | CH | C0H | 4 p | ±0.1pF, ±0.25pF | 480 | 200 | 0.2±0.02 | R |
| EMK042 CH4R1[D-W | | | CH | C0H | 4.1 p | ±0.1pF, ±0.25pF | 482 | 200 | 0.2±0.02 | R |
| EMK042 CH4R2[D-W | | | CH | C0H | 4.2 p | ±0.1pF, ±0.25pF | 484 | 200 | 0.2±0.02 | R |
| EMK042 CH4R3[D-W | | | CH | C0H | 4.3 p | ±0.1pF, ±0.25pF | 486 | 200 | 0.2±0.02 | R |
| EMK042 CH4R4[D-W | | | CH | C0H | 4.4 p | ±0.1pF, ±0.25pF | 488 | 200 | 0.2±0.02 | R |
| EMK042 CH4R5[D-W | | | CH | C0H | 4.5 p | ±0.1pF, ±0.25pF | 490 | 200 | 0.2±0.02 | R |
| EMK042 CH4R6[D-W | | | CH | C0H | 4.6 p | ±0.1pF, ±0.25pF | 492 | 200 | 0.2±0.02 | R |
| EMK042 CH4R7[D-W | | | CH | C0H | 4.7 p | ±0.1pF, ±0.25pF | 494 | 200 | 0.2±0.02 | R |
| EMK042 CH4R8[D-W | | | CH | C0H | 4.8 p | ±0.1pF, ±0.25pF | 496 | 200 | 0.2±0.02 | R |
| EMK042 CH4R9[D-W | | | CH | C0H | 4.9 p | ±0.1pF, ±0.25pF | 498 | 200 | 0.2±0.02 | R |
| EMK042 CH050[D-W | | | CH | C0H | 5 p | ±0.1pF, ±0.25pF | 500 | 200 | 0.2±0.02 | R |
| EMK042 CH5R1DD-W | | | CH | C0H | 5.1 p | ±0.5pF | 502 | 200 | 0.2±0.02 | R |
| EMK042 CH5R2DD-W | | | CH | C0H | 5.2 p | ±0.5pF | 504 | 200 | 0.2±0.02 | R |
| EMK042 CH5R3DD-W | | | CH | C0H | 5.3 p | ±0.5pF | 506 | 200 | 0.2±0.02 | R |
| EMK042 CH5R4DD-W | | | CH | C0H | 5.4 p | ±0.5pF | 508 | 200 | 0.2±0.02 | R |
| EMK042 CH5R5DD-W | | | CH | C0H | 5.5 p | ±0.5pF | 510 | 200 | 0.2±0.02 | R |
| EMK042 CH5R6DD-W | | | CH | C0H | 5.6 p | ±0.5pF | 512 | 200 | 0.2±0.02 | R |
| EMK042 CH5R7DD-W | | | CH | C0H | 5.7 p | ±0.5pF | 514 | 200 | 0.2±0.02 | R |
| EMK042 CH5R8DD-W | | | CH | C0H | 5.8 p | ±0.5pF | 516 | 200 | 0.2±0.02 | R |
| EMK042 CH5R9DD-W | | | CH | C0H | 5.9 p | ±0.5pF | 518 | 200 | 0.2±0.02 | R |
| EMK042 CH060DD-W | | | CH | C0H | 6 p | ±0.5pF | 520 | 200 | 0.2±0.02 | R |
| EMK042 CH6R1DD-W | | | CH | C0H | 6.1 p | ±0.5pF | 522 | 200 | 0.2±0.02 | R |
| EMK042 CH6R2DD-W | | | CH | C0H | 6.2 p | ±0.5pF | 524 | 200 | 0.2±0.02 | R |
| EMK042 CH6R3DD-W | | | CH | C0H | 6.3 p | ±0.5pF | 526 | 200 | 0.2±0.02 | R |
| EMK042 CH6R4DD-W | | | CH | C0H | 6.4 p | ±0.5pF | 528 | 200 | 0.2±0.02 | R |
| EMK042 CH6R5DD-W | | | CH | C0H | 6.5 p | ±0.5pF | 530 | 200 | 0.2±0.02 | R |
| EMK042 CH6R6DD-W | | | CH | C0H | 6.6 p | ±0.5pF | 532 | 200 | 0.2±0.02 | R |
| EMK042 CH6R7DD-W | | | CH | C0H | 6.7 p | ±0.5pF | 534 | 200 | 0.2±0.02 | R |
| EMK042 CH6R8DD-W | | | CH | C0H | 6.8 p | ±0.5pF | 536 | 200 | 0.2±0.02 | R |
| EMK042 CH6R9DD-W | | | CH | C0H | 6.9 p | ±0.5pF | 538 | 200 | 0.2±0.02 | R |
| EMK042 CH070DD-W | | | CH | C0H | 7 p | ±0.5pF | 540 | 200 | 0.2±0.02 | R |
| EMK042 CH7R1DD-W | | | CH | C0H | 7.1 p | ±0.5pF | 542 | 200 | 0.2±0.02 | R |
| EMK042 CH7R2DD-W | | | CH | C0H | 7.2 p | ±0.5pF | 544 | 200 | 0.2±0.02 | R |
| EMK042 CH7R3DD-W | | | CH | C0H | 7.3 p | ±0.5pF | 546 | 200 | 0.2±0.02 | R |
| EMK042 CH7R4DD-W | | | CH | C0H | 7.4 p | ±0.5pF | 548 | 200 | 0.2±0.02 | R |
| EMK042 CH7R5DD-W | | | CH | C0H | 7.5 p | ±0.5pF | 550 | 200 | 0.2±0.02 | R |
| EMK042 CH7R6DD-W | | | CH | C0H | 7.6 p | ±0.5pF | 552 | 200 | 0.2±0.02 | R |
| EMK042 CH7R7DD-W | | | CH | C0H | 7.7 p | ±0.5pF | 554 | 200 | 0.2±0.02 | R |
| EMK042 CH7R8DD-W | | | CH | C0H | 7.8 p | ±0.5pF | 556 | 200 | 0.2±0.02 | R |
| EMK042 CH7R9DD-W | | | CH | C0H | 7.9 p | ±0.5pF | 558 | 200 | 0.2±0.02 | R |
| EMK042 CH080DD-W | | | CH | C0H | 8 p | ±0.5pF | 560 | 200 | 0.2±0.02 | R |
| EMK042 CH8R1DD-W | | | CH | C0H | 8.1 p | ±0.5pF | 562 | 200 | 0.2±0.02 | R |
| EMK042 CH8R2DD-W | | | CH | C0H | 8.2 p | ±0.5pF | 564 | 200 | 0.2±0.02 | R |
| EMK042 CH8R3DD-W | | | CH | C0H | 8.3 p | ±0.5pF | 566 | 200 | 0.2±0.02 | R |
| EMK042 CH8R4DD-W | | | CH | C0H | 8.4 p | ±0.5pF | 568 | 200 | 0.2±0.02 | R |
| EMK042 CH8R5DD-W | | | CH | C0H | 8.5 p | ±0.5pF | 570 | 200 | 0.2±0.02 | R |
| EMK042 CH8R6DD-W | | | CH | C0H | 8.6 p | ±0.5pF | 572 | 200 | 0.2±0.02 | R |
| EMK042 CH8R7DD-W | | | CH | C0H | 8.7 p | ±0.5pF | 574 | 200 | 0.2±0.02 | R |
| EMK042 CH8R8DD-W | | | CH | C0H | 8.8 p | ±0.5pF | 576 | 200 | 0.2±0.02 | R |
| EMK042 CH8R9DD-W | | | CH | C0H | 8.9 p | ±0.5pF | 578 | 200 | 0.2±0.02 | R |
| EMK042 CH090DD-W | | | CH | C0H | 9 p | ±0.5pF | 580 | 200 | 0.2±0.02 | R |
| EMK042 CH9R1DD-W | | | CH | C0H | 9.1 p | ±0.5pF | 582 | 200 | 0.2±0.02 | R |
| EMK042 CH9R2DD-W | | | CH | C0H | 9.2 p | ±0.5pF | 584 | 200 | 0.2±0.02 | R |
| EMK042 CH9R3DD-W | | | CH | C0H | 9.3 p | ±0.5pF | 586 | 200 | 0.2±0.02 | R |
| EMK042 CH9R4DD-W | | | CH | C0H | 9.4 p | ±0.5pF | 588 | 200 | 0.2±0.02 | R |
| EMK042 CH9R5DD-W | | | CH | C0H | 9.5 p | ±0.5pF | 590 | 200 | 0.2±0.02 | R |
| EMK042 CH9R6DD-W | | | CH | C0H | 9.6 p | ±0.5pF | 592 | 200 | 0.2±0.02 | R |
| EMK042 CH9R7DD-W | | | CH | C0H | 9.7 p | ±0.5pF | 594 | 200 | 0.2±0.02 | R |
| EMK042 CH9R8DD-W | | | CH | C0H | 9.8 p | ±0.5pF | 596 | 200 | 0.2±0.02 | R |
| EMK042 CH9R9DD-W | | | CH | C0H | 9.9 p | ±0.5pF | 598 | 200 | 0.2±0.02 | R |
| EMK042 CH100DD-W | | | CH | C0H | 10 p | ±0.5pF | 600 | 200 | 0.2±0.02 | R |
| EMK042 CH110JD-W | | | CH | C0H | 11 p | ±5% | 620 | 200 | 0.2±0.02 | R |
| EMK042 CH120JD-W | | | CH | C0H | 12 p | ±5% | 640 | 200 | 0.2±0.02 | R |
| EMK042 CH130JD-W | | | CH | C0H | 13 p | ±5% | 660 | 200 | 0.2±0.02 | R |
| EMK042 CH150JD-W | | | CH | C0H | 15 p | ±5% | 700 | 200 | 0.2±0.02 | R |
| EMK042 CH160JC-W | | | CH | C0H | 16 p | ±5% | 720 | 200 | 0.2±0.02 | R |
| EMK042 CH180JC-W | | | CH | C0H | 18 p | ±5% | 760 | 200 | 0.2±0.02 | R |
| EMK042 CH200JC-W | | | CH | C0H | 20 p | ±5% | 800 | 200 | 0.2±0.02 | R |
| EMK042 CH220JC-W | | | CH | C0H | 22 p | ±5% | 840 | 200 | 0.2±0.02 | R |
| EMK042 CH240JC-W | | | CH | C0H | 24 p | ±5% | 880 | 200 | 0.2±0.02 | R |
| EMK042 CH270JC-W | | | CH | C0H | 27 p | ±5% | 940 | 200 | 0.2±0.02 | R |
| EMK042 CH300JC-W | | | CH | C0H | 30 p | ±5% | 1000 | 200 | 0.2±0.02 | R |
| EMK042 CH330JC-W | | | CH | C0H | 33 p | ±5% | 1000 | 200 | 0.2±0.02 | R |
| EMK042 CH360JC-W | | | CH | C0H | 36 p | ±5% | 1000 | 200 | 0.2±0.02 | R |
| EMK042 CH390JC-W | | | CH | C0H | 39 p | ±5% | 1000 | 200 | 0.2±0.02 | R |
| EMK042 CH430JC-W | | | CH | C0H | 43 p | ±5% | 1000 | 200 | 0.2±0.02 | R |
| EMK042 CH470JC-W | | | CH | C0H | 47 p | ±5% | 1000 | 200 | 0.2±0.02 | R |
| EMK042 CH510JC-W | | | CH | C0H | 51 p | ±5% | 1000 | 200 | 0.2±0.02 | R |
| EMK042 CH560JC-W | | | CH | C0H | 56 p | ±5% | 1000 | 200 | 0.2±0.02 | R |
| EMK042 CH620JC-W | | | CH | C0H | 62 p | ±5% | 1000 | 200 | 0.2±0.02 | R |
| EMK042 CH680JC-W | | | CH | C0H | 68 p | ±5% | 1000 | 200 | 0.2±0.02 | R |
| EMK042 CH750JC-W | | | CH | C0H | 75 p | ±5% | 1000 | 200 | 0.2±0.02 | R |
| EMK042 CH820JC-W | | | CH | C0H | 82 p | ±5% | 1000 | 200 | 0.2±0.02 | R |
| EMK042 CH910JC-W | | | CH | C0H | 91 p | ±5% | 1000 | 200 | 0.2±0.02 | R |
| EMK042 CH101JC-W | | | CH | C0H | 100 p | ±5% | 1000 | 200 | 0.2±0.02 | R |

16

| Part number 1 | Part number 2 | Rated voltage [V] | Temperature characteristics | | Capacitance [F] | Capacitance tolerance [%] | Q (at 1MHz) min | HTLT Rated voltage x % | Thickness ³ [mm] | Soldering R:Reflow W:Wave |
|------------------|---------------|-------------------|-----------------------------|-----|-----------------|---------------------------|-----------------|------------------------|-----------------------------|---------------------------|
| | | | | | | | | | | |
| UMK063 CG0R2CT-F | | 50 | CG | C0G | 0.2 p | ±0.25pF | 404 | 200 | 0.3±0.03 | R |
| UMK063 CG0R3CT-F | | | CG | C0G | 0.3 p | ±0.25pF | 406 | 200 | 0.3±0.03 | R |
| UMK063 CG0R4CT-F | | | CG | C0G | 0.4 p | ±0.25pF | 408 | 200 | 0.3±0.03 | R |
| UMK063 CG0R5CT-F | | | CG | C0G | 0.5 p | ±0.25pF | 410 | 200 | 0.3±0.03 | R |
| UMK063 CG0R6CT-F | | | CG | C0G | 0.6 p | ±0.25pF | 412 | 200 | 0.3±0.03 | R |
| UMK063 CG0R7CT-F | | | CG | C0G | 0.7 p | ±0.25pF | 414 | 200 | 0.3±0.03 | R |
| UMK063 CGR75CT-F | | | CG | C0G | 0.75 p | ±0.25pF | 415 | 200 | 0.3±0.03 | R |
| UMK063 CG0R8CT-F | | | CG | C0G | 0.8 p | ±0.25pF | 416 | 200 | 0.3±0.03 | R |
| UMK063 CG0R9CT-F | | | CG | C0G | 0.9 p | ±0.25pF | 418 | 200 | 0.3±0.03 | R |
| UMK063 CG010CT-F | | | CG | C0G | 1 p | ±0.25pF | 420 | 200 | 0.3±0.03 | R |
| UMK063 CG1R1CT-F | | | CG | C0G | 1.1 p | ±0.25pF | 422 | 200 | 0.3±0.03 | R |
| UMK063 CG1R2CT-F | | | CG | C0G | 1.2 p | ±0.25pF | 424 | 200 | 0.3±0.03 | R |
| UMK063 CG1R3CT-F | | | CG | C0G | 1.3 p | ±0.25pF | 426 | 200 | 0.3±0.03 | R |
| UMK063 CG1R4CT-F | | | CG | C0G | 1.4 p | ±0.25pF | 428 | 200 | 0.3±0.03 | R |
| UMK063 CG1R5CT-F | | | CG | C0G | 1.5 p | ±0.25pF | 430 | 200 | 0.3±0.03 | R |
| UMK063 CG1R6CT-F | | | CG | C0G | 1.6 p | ±0.25pF | 432 | 200 | 0.3±0.03 | R |
| UMK063 CG1R7CT-F | | | CG | C0G | 1.7 p | ±0.25pF | 434 | 200 | 0.3±0.03 | R |
| UMK063 CG1R8CT-F | | | CG | C0G | 1.8 p | ±0.25pF | 436 | 200 | 0.3±0.03 | R |
| UMK063 CG1R9CT-F | | | CG | C0G | 1.9 p | ±0.25pF | 438 | 200 | 0.3±0.03 | R |
| UMK063 CG020CT-F | | | CG | C0G | 2 p | ±0.25pF | 440 | 200 | 0.3±0.03 | R |
| UMK063 CG2R1CT-F | | | CG | C0G | 2.1 p | ±0.25pF | 442 | 200 | 0.3±0.03 | R |
| UMK063 CG2R2CT-F | | | CG | C0G | 2.2 p | ±0.25pF | 444 | 200 | 0.3±0.03 | R |
| UMK063 CG2R3CT-F | | | CG | C0G | 2.3 p | ±0.25pF | 446 | 200 | 0.3±0.03 | R |
| UMK063 CG2R4CT-F | | | CG | C0G | 2.4 p | ±0.25pF | 448 | 200 | 0.3±0.03 | R |
| UMK063 CG2R5CT-F | | | CG | C0G | 2.5 p | ±0.25pF | 450 | 200 | 0.3±0.03 | R |
| UMK063 CG2R6CT-F | | | CG | C0G | 2.6 p | ±0.25pF | 452 | 200 | 0.3±0.03 | R |
| UMK063 CG2R7CT-F | | | CG | C0G | 2.7 p | ±0.25pF | 454 | 200 | 0.3±0.03 | R |
| UMK063 CG2R8CT-F | | | CG | C0G | 2.8 p | ±0.25pF | 456 | 200 | 0.3±0.03 | R |
| UMK063 CG2R9CT-F | | | CG | C0G | 2.9 p | ±0.25pF | 458 | 200 | 0.3±0.03 | R |
| UMK063 CG030CT-F | | | CG | C0G | 3 p | ±0.25pF | 460 | 200 | 0.3±0.03 | R |
| UMK063 CG3R1CT-F | | | CG | C0G | 3.1 p | ±0.25pF | 462 | 200 | 0.3±0.03 | R |
| UMK063 CG3R2CT-F | | | CG | C0G | 3.2 p | ±0.25pF | 464 | 200 | 0.3±0.03 | R |
| UMK063 CG3R3CT-F | | | CG | C0G | 3.3 p | ±0.25pF | 466 | 200 | 0.3±0.03 | R |
| UMK063 CG3R4CT-F | | | CG | C0G | 3.4 p | ±0.25pF | 468 | 200 | 0.3±0.03 | R |
| UMK063 CG3R5CT-F | | | CG | C0G | 3.5 p | ±0.25pF | 470 | 200 | 0.3±0.03 | R |
| UMK063 CG3R6CT-F | | | CG | C0G | 3.6 p | ±0.25pF | 472 | 200 | 0.3±0.03 | R |
| UMK063 CG3R7CT-F | | | CG | C0G | 3.7 p | ±0.25pF | 474 | 200 | 0.3±0.03 | R |
| UMK063 CG3R8CT-F | | | CG | C0G | 3.8 p | ±0.25pF | 476 | 200 | 0.3±0.03 | R |
| UMK063 CG3R9CT-F | | | CG | C0G | 3.9 p | ±0.25pF | 478 | 200 | 0.3±0.03 | R |
| UMK063 CG040CT-F | | | CG | C0G | 4 p | ±0.25pF | 480 | 200 | 0.3±0.03 | R |
| UMK063 CG4R1CT-F | | | CG | C0G | 4.1 p | ±0.25pF | 482 | 200 | 0.3±0.03 | R |
| UMK063 CG4R2CT-F | | | CG | C0G | 4.2 p | ±0.25pF | 484 | 200 | 0.3±0.03 | R |
| UMK063 CG4R3CT-F | | | CG | C0G | 4.3 p | ±0.25pF | 486 | 200 | 0.3±0.03 | R |
| UMK063 CG4R4CT-F | | | CG | C0G | 4.4 p | ±0.25pF | 488 | 200 | 0.3±0.03 | R |
| UMK063 CG4R5CT-F | | | CG | C0G | 4.5 p | ±0.25pF | 490 | 200 | 0.3±0.03 | R |
| UMK063 CG4R6CT-F | | | CG | C0G | 4.6 p | ±0.25pF | 492 | 200 | 0.3±0.03 | R |
| UMK063 CG4R7CT-F | | | CG | C0G | 4.7 p | ±0.25pF | 494 | 200 | 0.3±0.03 | R |
| UMK063 CG4R8CT-F | | | CG | C0G | 4.8 p | ±0.25pF | 496 | 200 | 0.3±0.03 | R |
| UMK063 CG4R9CT-F | | | CG | C0G | 4.9 p | ±0.25pF | 498 | 200 | 0.3±0.03 | R |
| UMK063 CG050CT-F | | | CG | C0G | 5 p | ±0.25pF | 500 | 200 | 0.3±0.03 | R |
| UMK063 CG5R1DT-F | | | CG | C0G | 5.1 p | ±0.5pF | 502 | 200 | 0.3±0.03 | R |
| UMK063 CG5R2DT-F | | | CG | C0G | 5.2 p | ±0.5pF | 504 | 200 | 0.3±0.03 | R |
| UMK063 CG5R3DT-F | | | CG | C0G | 5.3 p | ±0.5pF | 506 | 200 | 0.3±0.03 | R |
| UMK063 CG5R4DT-F | | | CG | C0G | 5.4 p | ±0.5pF | 508 | 200 | 0.3±0.03 | R |
| UMK063 CG5R5DT-F | | | CG | C0G | 5.5 p | ±0.5pF | 510 | 200 | 0.3±0.03 | R |
| UMK063 CG5R6DT-F | | | CG | C0G | 5.6 p | ±0.5pF | 512 | 200 | 0.3±0.03 | R |
| UMK063 CG5R7DT-F | | | CG | C0G | 5.7 p | ±0.5pF | 514 | 200 | 0.3±0.03 | R |
| UMK063 CG5R8DT-F | | | CG | C0G | 5.8 p | ±0.5pF | 516 | 200 | 0.3±0.03 | R |
| UMK063 CG5R9DT-F | | | CG | C0G | 5.9 p | ±0.5pF | 518 | 200 | 0.3±0.03 | R |
| UMK063 CG060DT-F | | | CG | C0G | 6 p | ±0.5pF | 520 | 200 | 0.3±0.03 | R |
| UMK063 CG6R1DT-F | | | CG | C0G | 6.1 p | ±0.5pF | 522 | 200 | 0.3±0.03 | R |
| UMK063 CG6R2DT-F | | | CG | C0G | 6.2 p | ±0.5pF | 524 | 200 | 0.3±0.03 | R |
| UMK063 CG6R3DT-F | | | CG | C0G | 6.3 p | ±0.5pF | 526 | 200 | 0.3±0.03 | R |
| UMK063 CG6R4DT-F | | | CG | C0G | 6.4 p | ±0.5pF | 528 | 200 | 0.3±0.03 | R |
| UMK063 CG6R5DT-F | | | CG | C0G | 6.5 p | ±0.5pF | 530 | 200 | 0.3±0.03 | R |
| UMK063 CG6R6DT-F | | | CG | C0G | 6.6 p | ±0.5pF | 532 | 200 | 0.3±0.03 | R |
| UMK063 CG6R7DT-F | | | CG | C0G | 6.7 p | ±0.5pF | 534 | 200 | 0.3±0.03 | R |
| UMK063 CG6R8DT-F | | | CG | C0G | 6.8 p | ±0.5pF | 536 | 200 | 0.3±0.03 | R |
| UMK063 CG6R9DT-F | | | CG | C0G | 6.9 p | ±0.5pF | 538 | 200 | 0.3±0.03 | R |
| UMK063 CG070DT-F | | | CG | C0G | 7 p | ±0.5pF | 540 | 200 | 0.3±0.03 | R |
| UMK063 CG7R1DT-F | | | CG | C0G | 7.1 p | ±0.5pF | 542 | 200 | 0.3±0.03 | R |
| UMK063 CG7R2DT-F | | | CG | C0G | 7.2 p | ±0.5pF | 544 | 200 | 0.3±0.03 | R |
| UMK063 CG7R3DT-F | | | CG | C0G | 7.3 p | ±0.5pF | 546 | 200 | 0.3±0.03 | R |
| UMK063 CG7R4DT-F | | | CG | C0G | 7.4 p | ±0.5pF | 548 | 200 | 0.3±0.03 | R |
| UMK063 CG7R5DT-F | | | CG | C0G | 7.5 p | ±0.5pF | 550 | 200 | 0.3±0.03 | R |
| UMK063 CG7R6DT-F | | | CG | C0G | 7.6 p | ±0.5pF | 552 | 200 | 0.3±0.03 | R |
| UMK063 CG7R7DT-F | | | CG | C0G | 7.7 p | ±0.5pF | 554 | 200 | 0.3±0.03 | R |
| UMK063 CG7R8DT-F | | | CG | C0G | 7.8 p | ±0.5pF | 556 | 200 | 0.3±0.03 | R |
| UMK063 CG7R9DT-F | | | CG | C0G | 7.9 p | ±0.5pF | 558 | 200 | 0.3±0.03 | R |
| UMK063 CG080DT-F | | | CG | C0G | 8 p | ±0.5pF | 560 | 200 | 0.3±0.03 | R |
| UMK063 CG8R1DT-F | | | CG | C0G | 8.1 p | ±0.5pF | 562 | 200 | 0.3±0.03 | R |
| UMK063 CG8R2DT-F | | | CG | C0G | 8.2 p | ±0.5pF | 564 | 200 | 0.3±0.03 | R |
| UMK063 CG8R3DT-F | | | CG | C0G | 8.3 p | ±0.5pF | 566 | 200 | 0.3±0.03 | R |
| UMK063 CG8R4DT-F | | | CG | C0G | 8.4 p | ±0.5pF | 568 | 200 | 0.3±0.03 | R |
| UMK063 CG8R5DT-F | | | CG | C0G | 8.5 p | ±0.5pF | 570 | 200 | 0.3±0.03 | R |
| UMK063 CG8R6DT-F | | | CG | C0G | 8.6 p | ±0.5pF | 572 | 200 | 0.3±0.03 | R |
| UMK063 CG8R7DT-F | | | CG | C0G | 8.7 p | ±0.5pF | 574 | 200 | 0.3±0.03 | R |
| UMK063 CG8R8DT-F | | | CG | C0G | 8.8 p | ±0.5pF | 576 | 200 | 0.3±0.03 | R |

▶ This catalog contains the typical specification only due to the limitation of space. When you consider the purchase of our products, please check our specification. For details of each product (characteristics graph, reliability information, precautions for use, and so on), see our Web site (<http://www.ty-top.com/>).

PARTS NUMBER

| Part number 1 | Part number 2 | Rated voltage [V] | Temperature characteristics | | Capacitance [F] | Capacitance tolerance [%] | Q (at 1MHz) min | HTLT | Thickness*3 [mm] | Soldering R:Reflow W:Wave |
|------------------|---------------|-------------------|-----------------------------|-----|-----------------|---------------------------|-----------------|-------------------|------------------|---------------------------|
| | | | | | | | | Rated voltage x % | | |
| UMK063 CG8R9DT-F | | 50 | CG | C0G | 8.9 p | ±0.5pF | 578 | 200 | 0.3±0.03 | R |
| UMK063 CG090DT-F | | | CG | C0G | 9 p | ±0.5pF | 580 | 200 | 0.3±0.03 | R |
| UMK063 CG9R1DT-F | | | CG | C0G | 9.1 p | ±0.5pF | 582 | 200 | 0.3±0.03 | R |
| UMK063 CG9R2DT-F | | | CG | C0G | 9.2 p | ±0.5pF | 584 | 200 | 0.3±0.03 | R |
| UMK063 CG9R3DT-F | | | CG | C0G | 9.3 p | ±0.5pF | 586 | 200 | 0.3±0.03 | R |
| UMK063 CG9R4DT-F | | | CG | C0G | 9.4 p | ±0.5pF | 588 | 200 | 0.3±0.03 | R |
| UMK063 CG9R5DT-F | | | CG | C0G | 9.5 p | ±0.5pF | 590 | 200 | 0.3±0.03 | R |
| UMK063 CG9R6DT-F | | | CG | C0G | 9.6 p | ±0.5pF | 592 | 200 | 0.3±0.03 | R |
| UMK063 CG9R7DT-F | | | CG | C0G | 9.7 p | ±0.5pF | 594 | 200 | 0.3±0.03 | R |
| UMK063 CG9R8DT-F | | | CG | C0G | 9.8 p | ±0.5pF | 596 | 200 | 0.3±0.03 | R |
| UMK063 CG9R9DT-F | | | CG | C0G | 9.9 p | ±0.5pF | 598 | 200 | 0.3±0.03 | R |
| UMK063 CG100DT-F | | | CG | C0G | 10 p | ±0.5pF | 600 | 200 | 0.3±0.03 | R |
| UMK063 CG110JT-F | | | CG | C0G | 11 p | ±5% | 620 | 200 | 0.3±0.03 | R |
| UMK063 CG120JT-F | | | CG | C0G | 12 p | ±5% | 640 | 200 | 0.3±0.03 | R |
| UMK063 CG130JT-F | | | CG | C0G | 13 p | ±5% | 660 | 200 | 0.3±0.03 | R |
| UMK063 CG150JT-F | | | CG | C0G | 15 p | ±5% | 700 | 200 | 0.3±0.03 | R |
| UMK063 CG160JT-F | | | CG | C0G | 16 p | ±5% | 720 | 200 | 0.3±0.03 | R |
| UMK063 CG180JT-F | | | CG | C0G | 18 p | ±5% | 760 | 200 | 0.3±0.03 | R |
| UMK063 CG200JT-F | | | CG | C0G | 20 p | ±5% | 800 | 200 | 0.3±0.03 | R |
| UMK063 CG220JT-F | | | CG | C0G | 22 p | ±5% | 840 | 200 | 0.3±0.03 | R |
| UMK063 CG240JT-F | | | CG | C0G | 24 p | ±5% | 880 | 200 | 0.3±0.03 | R |
| UMK063 CG270JT-F | | | CG | C0G | 27 p | ±5% | 940 | 200 | 0.3±0.03 | R |
| UMK063 CG300JT-F | | | CG | C0G | 30 p | ±5% | 1000 | 200 | 0.3±0.03 | R |
| UMK063 CG330JT-F | | | CG | C0G | 33 p | ±5% | 1000 | 200 | 0.3±0.03 | R |
| UMK063 CG360JT-F | | | CG | C0G | 36 p | ±5% | 1000 | 200 | 0.3±0.03 | R |
| UMK063 CG390JT-F | | | CG | C0G | 39 p | ±5% | 1000 | 200 | 0.3±0.03 | R |
| UMK063 CG430JT-F | | | CG | C0G | 43 p | ±5% | 1000 | 200 | 0.3±0.03 | R |
| UMK063 CG470JT-F | | | CG | C0G | 47 p | ±5% | 1000 | 200 | 0.3±0.03 | R |
| UMK063 CG510JT-F | | | CG | C0G | 51 p | ±5% | 1000 | 200 | 0.3±0.03 | R |
| UMK063 CG560JT-F | | | CG | C0G | 56 p | ±5% | 1000 | 200 | 0.3±0.03 | R |
| UMK063 CG620JT-F | | | CG | C0G | 62 p | ±5% | 1000 | 200 | 0.3±0.03 | R |
| UMK063 CG680JT-F | | | CG | C0G | 68 p | ±5% | 1000 | 200 | 0.3±0.03 | R |
| UMK063 CG750JT-F | | | CG | C0G | 75 p | ±5% | 1000 | 200 | 0.3±0.03 | R |
| UMK063 CG820JT-F | | | CG | C0G | 82 p | ±5% | 1000 | 200 | 0.3±0.03 | R |
| UMK063 CG910JT-F | | | CG | C0G | 91 p | ±5% | 1000 | 200 | 0.3±0.03 | R |
| UMK063 CG101JT-F | | | CG | C0G | 100 p | ±5% | 1000 | 200 | 0.3±0.03 | R |
| UMK063 CG111JT-F | | | CG | C0G | 110 p | ±5% | 1000 | 150 | 0.3±0.03 | R |
| UMK063 CG121JT-F | | | CG | C0G | 120 p | ±5% | 1000 | 150 | 0.3±0.03 | R |
| UMK063 CG131JT-F | | | CG | C0G | 130 p | ±5% | 1000 | 150 | 0.3±0.03 | R |
| UMK063 CG151JT-F | | | CG | C0G | 150 p | ±5% | 1000 | 150 | 0.3±0.03 | R |
| UMK063 CG181JT-F | | | CG | C0G | 180 p | ±5% | 1000 | 150 | 0.3±0.03 | R |
| UMK063 CG201JT-F | | | CG | C0G | 200 p | ±5% | 1000 | 150 | 0.3±0.03 | R |
| UMK063 CG221JT-F | | | CG | C0G | 220 p | ±5% | 1000 | 200 | 0.3±0.03 | R |

【Temperature Characteristic CΔ : CΔ/C0Δ】 0.3mm thickness(T)

| Part number 1 | Part number 2 | Rated voltage [V] | Temperature characteristics | | Capacitance [F] | Capacitance tolerance [%] | Q (at 1MHz) min | HTLT | Thickness*3 [mm] | Soldering R:Reflow W:Wave |
|------------------|---------------|-------------------|-----------------------------|-----|-----------------|---------------------------|-----------------|-------------------|------------------|---------------------------|
| | | | | | | | | Rated voltage x % | | |
| UMK063 CK0R2CT-F | | 50 | CK | C0K | 0.2 p | ±0.25pF | 404 | 200 | 0.3±0.03 | R |
| UMK063 CK0R3CT-F | | | CK | C0K | 0.3 p | ±0.25pF | 406 | 200 | 0.3±0.03 | R |
| UMK063 CK0R4CT-F | | | CK | C0K | 0.4 p | ±0.25pF | 408 | 200 | 0.3±0.03 | R |
| UMK063 CK0R5CT-F | | | CK | C0K | 0.5 p | ±0.25pF | 410 | 200 | 0.3±0.03 | R |
| UMK063 CK0R6CT-F | | | CK | C0K | 0.6 p | ±0.25pF | 412 | 200 | 0.3±0.03 | R |
| UMK063 CK0R7CT-F | | | CK | C0K | 0.7 p | ±0.25pF | 414 | 200 | 0.3±0.03 | R |
| UMK063 CKR75CT-F | | | CK | C0K | 0.75 p | ±0.25pF | 415 | 200 | 0.3±0.03 | R |
| UMK063 CK0R8CT-F | | | CK | C0K | 0.8 p | ±0.25pF | 416 | 200 | 0.3±0.03 | R |
| UMK063 CK0R9CT-F | | | CK | C0K | 0.9 p | ±0.25pF | 418 | 200 | 0.3±0.03 | R |
| UMK063 CK010CT-F | | | CK | C0K | 1 p | ±0.25pF | 420 | 200 | 0.3±0.03 | R |
| UMK063 CK1R1CT-F | | | CK | C0K | 1.1 p | ±0.25pF | 422 | 200 | 0.3±0.03 | R |
| UMK063 CK1R2CT-F | | | CK | C0K | 1.2 p | ±0.25pF | 424 | 200 | 0.3±0.03 | R |
| UMK063 CK1R3CT-F | | | CK | C0K | 1.3 p | ±0.25pF | 426 | 200 | 0.3±0.03 | R |
| UMK063 CK1R4CT-F | | | CK | C0K | 1.4 p | ±0.25pF | 428 | 200 | 0.3±0.03 | R |
| UMK063 CK1R5CT-F | | | CK | C0K | 1.5 p | ±0.25pF | 430 | 200 | 0.3±0.03 | R |
| UMK063 CK1R6CT-F | | | CK | C0K | 1.6 p | ±0.25pF | 432 | 200 | 0.3±0.03 | R |
| UMK063 CK1R7CT-F | | | CK | C0K | 1.7 p | ±0.25pF | 434 | 200 | 0.3±0.03 | R |
| UMK063 CK1R8CT-F | | | CK | C0K | 1.8 p | ±0.25pF | 436 | 200 | 0.3±0.03 | R |
| UMK063 CK1R9CT-F | | | CK | C0K | 1.9 p | ±0.25pF | 438 | 200 | 0.3±0.03 | R |
| UMK063 CK020CT-F | | | CK | C0K | 2 p | ±0.25pF | 440 | 200 | 0.3±0.03 | R |
| UMK063 CK2R1CT-F | | | CK | C0K | 2.1 p | ±0.25pF | 442 | 200 | 0.3±0.03 | R |
| UMK063 CK2R2CT-F | | | CK | C0K | 2.2 p | ±0.25pF | 444 | 200 | 0.3±0.03 | R |
| UMK063 CK2R3CT-F | | | CK | C0K | 2.3 p | ±0.25pF | 446 | 200 | 0.3±0.03 | R |
| UMK063 CK2R4CT-F | | | CK | C0K | 2.4 p | ±0.25pF | 448 | 200 | 0.3±0.03 | R |
| UMK063 CK2R5CT-F | | | CK | C0K | 2.5 p | ±0.25pF | 450 | 200 | 0.3±0.03 | R |
| UMK063 CK2R6CT-F | | | CK | C0K | 2.6 p | ±0.25pF | 452 | 200 | 0.3±0.03 | R |
| UMK063 CK2R7CT-F | | | CK | C0K | 2.7 p | ±0.25pF | 454 | 200 | 0.3±0.03 | R |
| UMK063 CK2R8CT-F | | | CK | C0K | 2.8 p | ±0.25pF | 456 | 200 | 0.3±0.03 | R |
| UMK063 CK2R9CT-F | | | CK | C0K | 2.9 p | ±0.25pF | 458 | 200 | 0.3±0.03 | R |
| UMK063 CJ030CT-F | | | CJ | C0J | 3 p | ±0.25pF | 460 | 200 | 0.3±0.03 | R |
| UMK063 CJ3R1CT-F | | | CJ | C0J | 3.1 p | ±0.25pF | 462 | 200 | 0.3±0.03 | R |
| UMK063 CJ3R2CT-F | | | CJ | C0J | 3.2 p | ±0.25pF | 464 | 200 | 0.3±0.03 | R |
| UMK063 CJ3R3CT-F | | | CJ | C0J | 3.3 p | ±0.25pF | 466 | 200 | 0.3±0.03 | R |
| UMK063 CJ3R4CT-F | | | CJ | C0J | 3.4 p | ±0.25pF | 468 | 200 | 0.3±0.03 | R |
| UMK063 CJ3R5CT-F | | | CJ | C0J | 3.5 p | ±0.25pF | 470 | 200 | 0.3±0.03 | R |
| UMK063 CJ3R6CT-F | | | CJ | C0J | 3.6 p | ±0.25pF | 472 | 200 | 0.3±0.03 | R |
| UMK063 CJ3R7CT-F | | | CJ | C0J | 3.7 p | ±0.25pF | 474 | 200 | 0.3±0.03 | R |
| UMK063 CJ3R8CT-F | | | CJ | C0J | 3.8 p | ±0.25pF | 476 | 200 | 0.3±0.03 | R |
| UMK063 CJ3R9CT-F | | | CJ | C0J | 3.9 p | ±0.25pF | 478 | 200 | 0.3±0.03 | R |
| UMK063 CH040CT-F | | | CH | C0H | 4 p | ±0.25pF | 480 | 200 | 0.3±0.03 | R |
| UMK063 CH4R1CT-F | | | CH | C0H | 4.1 p | ±0.25pF | 482 | 200 | 0.3±0.03 | R |
| UMK063 CH4R2CT-F | | | CH | C0H | 4.2 p | ±0.25pF | 484 | 200 | 0.3±0.03 | R |
| UMK063 CH4R3CT-F | | | CH | C0H | 4.3 p | ±0.25pF | 486 | 200 | 0.3±0.03 | R |

▶ This catalog contains the typical specification only due to the limitation of space. When you consider the purchase of our products, please check our specification. For details of each product (characteristics graph, reliability information, precautions for use, and so on), see our Web site (<http://www.ty-top.com/>).

| Part number 1 | Part number 2 | Rated voltage [V] | Temperature characteristics | | Capacitance [F] | Capacitance tolerance [%] | Q (at 1MHz) min | HLT | Thickness ³ [mm] | Soldering R,Reflow W,Wave |
|------------------|---------------|-------------------|-----------------------------|-----|-----------------|---------------------------|-----------------|-------------------|-----------------------------|---------------------------|
| | | | | | | | | Rated voltage x % | | |
| UMK063 CH4R4CT-F | | | CH | C0H | 4.4 p | ±0.25pF | 488 | 200 | 0.3±0.03 | R |
| UMK063 CH4R5CT-F | | | CH | C0H | 4.5 p | ±0.25pF | 490 | 200 | 0.3±0.03 | R |
| UMK063 CH4R6CT-F | | | CH | C0H | 4.6 p | ±0.25pF | 492 | 200 | 0.3±0.03 | R |
| UMK063 CH4R7CT-F | | | CH | C0H | 4.7 p | ±0.25pF | 494 | 200 | 0.3±0.03 | R |
| UMK063 CH4R8CT-F | | | CH | C0H | 4.8 p | ±0.25pF | 496 | 200 | 0.3±0.03 | R |
| UMK063 CH4R9CT-F | | | CH | C0H | 4.9 p | ±0.25pF | 498 | 200 | 0.3±0.03 | R |
| UMK063 CH050CT-F | | | CH | C0H | 5 p | ±0.25pF | 500 | 200 | 0.3±0.03 | R |
| UMK063 CH5R1DT-F | | | CH | C0H | 5.1 p | ±0.5pF | 502 | 200 | 0.3±0.03 | R |
| UMK063 CH5R2DT-F | | | CH | C0H | 5.2 p | ±0.5pF | 504 | 200 | 0.3±0.03 | R |
| UMK063 CH5R3DT-F | | | CH | C0H | 5.3 p | ±0.5pF | 506 | 200 | 0.3±0.03 | R |
| UMK063 CH5R4DT-F | | | CH | C0H | 5.4 p | ±0.5pF | 508 | 200 | 0.3±0.03 | R |
| UMK063 CH5R5DT-F | | | CH | C0H | 5.5 p | ±0.5pF | 510 | 200 | 0.3±0.03 | R |
| UMK063 CH5R6DT-F | | | CH | C0H | 5.6 p | ±0.5pF | 512 | 200 | 0.3±0.03 | R |
| UMK063 CH5R7DT-F | | | CH | C0H | 5.7 p | ±0.5pF | 514 | 200 | 0.3±0.03 | R |
| UMK063 CH5R8DT-F | | | CH | C0H | 5.8 p | ±0.5pF | 516 | 200 | 0.3±0.03 | R |
| UMK063 CH5R9DT-F | | | CH | C0H | 5.9 p | ±0.5pF | 518 | 200 | 0.3±0.03 | R |
| UMK063 CH060DT-F | | | CH | C0H | 6 p | ±0.5pF | 520 | 200 | 0.3±0.03 | R |
| UMK063 CH6R1DT-F | | | CH | C0H | 6.1 p | ±0.5pF | 522 | 200 | 0.3±0.03 | R |
| UMK063 CH6R2DT-F | | | CH | C0H | 6.2 p | ±0.5pF | 524 | 200 | 0.3±0.03 | R |
| UMK063 CH6R3DT-F | | | CH | C0H | 6.3 p | ±0.5pF | 526 | 200 | 0.3±0.03 | R |
| UMK063 CH6R4DT-F | | | CH | C0H | 6.4 p | ±0.5pF | 528 | 200 | 0.3±0.03 | R |
| UMK063 CH6R5DT-F | | | CH | C0H | 6.5 p | ±0.5pF | 530 | 200 | 0.3±0.03 | R |
| UMK063 CH6R6DT-F | | | CH | C0H | 6.6 p | ±0.5pF | 532 | 200 | 0.3±0.03 | R |
| UMK063 CH6R7DT-F | | | CH | C0H | 6.7 p | ±0.5pF | 534 | 200 | 0.3±0.03 | R |
| UMK063 CH6R8DT-F | | | CH | C0H | 6.8 p | ±0.5pF | 536 | 200 | 0.3±0.03 | R |
| UMK063 CH6R9DT-F | | | CH | C0H | 6.9 p | ±0.5pF | 538 | 200 | 0.3±0.03 | R |
| UMK063 CH070DT-F | | | CH | C0H | 7 p | ±0.5pF | 540 | 200 | 0.3±0.03 | R |
| UMK063 CH7R1DT-F | | | CH | C0H | 7.1 p | ±0.5pF | 542 | 200 | 0.3±0.03 | R |
| UMK063 CH7R2DT-F | | | CH | C0H | 7.2 p | ±0.5pF | 544 | 200 | 0.3±0.03 | R |
| UMK063 CH7R3DT-F | | | CH | C0H | 7.3 p | ±0.5pF | 546 | 200 | 0.3±0.03 | R |
| UMK063 CH7R4DT-F | | | CH | C0H | 7.4 p | ±0.5pF | 548 | 200 | 0.3±0.03 | R |
| UMK063 CH7R5DT-F | | | CH | C0H | 7.5 p | ±0.5pF | 550 | 200 | 0.3±0.03 | R |
| UMK063 CH7R6DT-F | | | CH | C0H | 7.6 p | ±0.5pF | 552 | 200 | 0.3±0.03 | R |
| UMK063 CH7R7DT-F | | | CH | C0H | 7.7 p | ±0.5pF | 554 | 200 | 0.3±0.03 | R |
| UMK063 CH7R8DT-F | | | CH | C0H | 7.8 p | ±0.5pF | 556 | 200 | 0.3±0.03 | R |
| UMK063 CH7R9DT-F | | | CH | C0H | 7.9 p | ±0.5pF | 558 | 200 | 0.3±0.03 | R |
| UMK063 CH080DT-F | | | CH | C0H | 8 p | ±0.5pF | 560 | 200 | 0.3±0.03 | R |
| UMK063 CH8R1DT-F | | | CH | C0H | 8.1 p | ±0.5pF | 562 | 200 | 0.3±0.03 | R |
| UMK063 CH8R2DT-F | | | CH | C0H | 8.2 p | ±0.5pF | 564 | 200 | 0.3±0.03 | R |
| UMK063 CH8R3DT-F | | | CH | C0H | 8.3 p | ±0.5pF | 566 | 200 | 0.3±0.03 | R |
| UMK063 CH8R4DT-F | | | CH | C0H | 8.4 p | ±0.5pF | 568 | 200 | 0.3±0.03 | R |
| UMK063 CH8R5DT-F | | | CH | C0H | 8.5 p | ±0.5pF | 570 | 200 | 0.3±0.03 | R |
| UMK063 CH8R6DT-F | | | CH | C0H | 8.6 p | ±0.5pF | 572 | 200 | 0.3±0.03 | R |
| UMK063 CH8R7DT-F | | | CH | C0H | 8.7 p | ±0.5pF | 574 | 200 | 0.3±0.03 | R |
| UMK063 CH8R8DT-F | | | CH | C0H | 8.8 p | ±0.5pF | 576 | 200 | 0.3±0.03 | R |
| UMK063 CH8R9DT-F | | | CH | C0H | 8.9 p | ±0.5pF | 578 | 200 | 0.3±0.03 | R |
| UMK063 CH090DT-F | | | CH | C0H | 9 p | ±0.5pF | 580 | 200 | 0.3±0.03 | R |
| UMK063 CH9R1DT-F | | | CH | C0H | 9.1 p | ±0.5pF | 582 | 200 | 0.3±0.03 | R |
| UMK063 CH9R2DT-F | | | CH | C0H | 9.2 p | ±0.5pF | 584 | 200 | 0.3±0.03 | R |
| UMK063 CH9R3DT-F | | | CH | C0H | 9.3 p | ±0.5pF | 586 | 200 | 0.3±0.03 | R |
| UMK063 CH9R4DT-F | | | CH | C0H | 9.4 p | ±0.5pF | 588 | 200 | 0.3±0.03 | R |
| UMK063 CH9R5DT-F | | | CH | C0H | 9.5 p | ±0.5pF | 590 | 200 | 0.3±0.03 | R |
| UMK063 CH9R6DT-F | | | CH | C0H | 9.6 p | ±0.5pF | 592 | 200 | 0.3±0.03 | R |
| UMK063 CH9R7DT-F | | | CH | C0H | 9.7 p | ±0.5pF | 594 | 200 | 0.3±0.03 | R |
| UMK063 CH9R8DT-F | | | CH | C0H | 9.8 p | ±0.5pF | 596 | 200 | 0.3±0.03 | R |
| UMK063 CH9R9DT-F | | | CH | C0H | 9.9 p | ±0.5pF | 598 | 200 | 0.3±0.03 | R |
| UMK063 CH100DT-F | | | CH | C0H | 10 p | ±0.5pF | 600 | 200 | 0.3±0.03 | R |
| UMK063 CH110JT-F | | | CH | C0H | 11 p | ±5% | 620 | 200 | 0.3±0.03 | R |
| UMK063 CH120JT-F | | | CH | C0H | 12 p | ±5% | 640 | 200 | 0.3±0.03 | R |
| UMK063 CH130JT-F | | | CH | C0H | 13 p | ±5% | 660 | 200 | 0.3±0.03 | R |
| UMK063 CH150JT-F | | | CH | C0H | 15 p | ±5% | 700 | 200 | 0.3±0.03 | R |
| UMK063 CH160JT-F | | | CH | C0H | 16 p | ±5% | 720 | 200 | 0.3±0.03 | R |
| UMK063 CH180JT-F | | | CH | C0H | 18 p | ±5% | 760 | 200 | 0.3±0.03 | R |
| UMK063 CH200JT-F | | | CH | C0H | 20 p | ±5% | 800 | 200 | 0.3±0.03 | R |
| UMK063 CH220JT-F | | | CH | C0H | 22 p | ±5% | 840 | 200 | 0.3±0.03 | R |
| UMK063 CH240JT-F | | | CH | C0H | 24 p | ±5% | 880 | 200 | 0.3±0.03 | R |
| UMK063 CH270JT-F | | | CH | C0H | 27 p | ±5% | 940 | 200 | 0.3±0.03 | R |
| UMK063 CH300JT-F | | | CH | C0H | 30 p | ±5% | 1000 | 200 | 0.3±0.03 | R |
| UMK063 CH330JT-F | | | CH | C0H | 33 p | ±5% | 1000 | 200 | 0.3±0.03 | R |
| UMK063 CH360JT-F | | | CH | C0H | 36 p | ±5% | 1000 | 200 | 0.3±0.03 | R |
| UMK063 CH390JT-F | | | CH | C0H | 39 p | ±5% | 1000 | 200 | 0.3±0.03 | R |
| UMK063 CH430JT-F | | | CH | C0H | 43 p | ±5% | 1000 | 200 | 0.3±0.03 | R |
| UMK063 CH470JT-F | | | CH | C0H | 47 p | ±5% | 1000 | 200 | 0.3±0.03 | R |
| UMK063 CH510JT-F | | | CH | C0H | 51 p | ±5% | 1000 | 200 | 0.3±0.03 | R |
| UMK063 CH560JT-F | | | CH | C0H | 56 p | ±5% | 1000 | 200 | 0.3±0.03 | R |
| UMK063 CH620JT-F | | | CH | C0H | 62 p | ±5% | 1000 | 200 | 0.3±0.03 | R |
| UMK063 CH680JT-F | | | CH | C0H | 68 p | ±5% | 1000 | 200 | 0.3±0.03 | R |
| UMK063 CH750JT-F | | | CH | C0H | 75 p | ±5% | 1000 | 200 | 0.3±0.03 | R |
| UMK063 CH820JT-F | | | CH | C0H | 82 p | ±5% | 1000 | 200 | 0.3±0.03 | R |
| UMK063 CH910JT-F | | | CH | C0H | 91 p | ±5% | 1000 | 200 | 0.3±0.03 | R |
| UMK063 CH101JT-F | | | CH | C0H | 100 p | ±5% | 1000 | 200 | 0.3±0.03 | R |
| UMK063 CH111JT-F | | | CH | C0H | 110 p | ±5% | 1000 | 150 | 0.3±0.03 | R |
| UMK063 CH121JT-F | | | CH | C0H | 120 p | ±5% | 1000 | 150 | 0.3±0.03 | R |
| UMK063 CH131JT-F | | | CH | C0H | 130 p | ±5% | 1000 | 150 | 0.3±0.03 | R |
| UMK063 CH151JT-F | | | CH | C0H | 150 p | ±5% | 1000 | 150 | 0.3±0.03 | R |
| UMK063 CH181JT-F | | | CH | C0H | 180 p | ±5% | 1000 | 150 | 0.3±0.03 | R |
| UMK063 CH201JT-F | | | CH | C0H | 200 p | ±5% | 1000 | 150 | 0.3±0.03 | R |
| UMK063 CH221JT-F | | | CH | C0H | 220 p | ±5% | 1000 | 150 | 0.3±0.03 | R |

50

▶ This catalog contains the typical specification only due to the limitation of space. When you consider the purchase of our products, please check our specification. For details of each product (characteristics graph, reliability information, precautions for use, and so on), see our Web site (<http://www.ty-top.com/>).

■ PARTS NUMBER

● 105TYPE

[Temperature Characteristic CG : CG/C0G] 0.5mm thickness(V)

| Part number 1 | Part number 2 | Rated voltage [V] | Temperature characteristics | | Capacitance [F] | Capacitance tolerance [%] | Q (at 1MHz) min | HTLT | Thickness*3 [mm] | Soldering R:Reflow W:Wave |
|------------------|---------------|-------------------|-----------------------------|-----|-----------------|---------------------------|-----------------|-------------------|------------------|---------------------------|
| | | | | | | | | Rated voltage x % | | |
| UMK105 CG0R5CV-F | | 50 | CG | C0G | 0.5 p | ±0.25pF | 410 | 200 | 0.5±0.05 | R |
| UMK105 CG010CV-F | | | CG | C0G | 1 p | ±0.25pF | 420 | 200 | 0.5±0.05 | R |
| UMK105 CG1R5CV-F | | | CG | C0G | 1.5 p | ±0.25pF | 430 | 200 | 0.5±0.05 | R |
| UMK105 CG020CV-F | | | CG | C0G | 2 p | ±0.25pF | 440 | 200 | 0.5±0.05 | R |
| UMK105 CG030CV-F | | | CG | C0G | 3 p | ±0.25pF | 460 | 200 | 0.5±0.05 | R |
| UMK105 CG040CV-F | | | CG | C0G | 4 p | ±0.25pF | 480 | 200 | 0.5±0.05 | R |
| UMK105 CG050CV-F | | | CG | C0G | 5 p | ±0.25pF | 500 | 200 | 0.5±0.05 | R |
| UMK105 CG060DV-F | | | CG | C0G | 6 p | ±0.5pF | 520 | 200 | 0.5±0.05 | R |
| UMK105 CG070DV-F | | | CG | C0G | 7 p | ±0.5pF | 540 | 200 | 0.5±0.05 | R |
| UMK105 CG080DV-F | | | CG | C0G | 8 p | ±0.5pF | 560 | 200 | 0.5±0.05 | R |
| UMK105 CG090DV-F | | | CG | C0G | 9 p | ±0.5pF | 580 | 200 | 0.5±0.05 | R |
| UMK105 CG100DV-F | | | CG | C0G | 10 p | ±0.5pF | 600 | 200 | 0.5±0.05 | R |
| UMK105 CG120JV-F | | | CG | C0G | 12 p | ±5% | 640 | 200 | 0.5±0.05 | R |
| UMK105 CG150JV-F | | | CG | C0G | 15 p | ±5% | 700 | 200 | 0.5±0.05 | R |
| UMK105 CG180JV-F | | | CG | C0G | 18 p | ±5% | 760 | 200 | 0.5±0.05 | R |
| UMK105 CG220JV-F | | | CG | C0G | 22 p | ±5% | 840 | 200 | 0.5±0.05 | R |
| UMK105 CG270JV-F | | | CG | C0G | 27 p | ±5% | 940 | 200 | 0.5±0.05 | R |
| UMK105 CG330JV-F | | | CG | C0G | 33 p | ±5% | 1000 | 200 | 0.5±0.05 | R |
| UMK105 CG390JV-F | | | CG | C0G | 39 p | ±5% | 1000 | 200 | 0.5±0.05 | R |
| UMK105 CG470JV-F | | | CG | C0G | 47 p | ±5% | 1000 | 200 | 0.5±0.05 | R |
| UMK105 CG560JV-F | | | CG | C0G | 56 p | ±5% | 1000 | 200 | 0.5±0.05 | R |
| UMK105 CG680JV-F | | | CG | C0G | 68 p | ±5% | 1000 | 200 | 0.5±0.05 | R |
| UMK105 CG820JV-F | | | CG | C0G | 82 p | ±5% | 1000 | 200 | 0.5±0.05 | R |
| UMK105 CG101JV-F | | | CG | C0G | 100 p | ±5% | 1000 | 200 | 0.5±0.05 | R |
| UMK105 CG121JV-F | | | CG | C0G | 120 p | ±5% | 1000 | 200 | 0.5±0.05 | R |
| UMK105 CG151JV-F | | | CG | C0G | 150 p | ±5% | 1000 | 200 | 0.5±0.05 | R |
| UMK105 CG181JV-F | | | CG | C0G | 180 p | ±5% | 1000 | 200 | 0.5±0.05 | R |
| UMK105 CG221JV-F | | | CG | C0G | 220 p | ±5% | 1000 | 200 | 0.5±0.05 | R |
| UMK105 CG271JV-F | | | CG | C0G | 270 p | ±5% | 1000 | 200 | 0.5±0.05 | R |
| UMK105 CG331JV-F | | | CG | C0G | 330 p | ±5% | 1000 | 200 | 0.5±0.05 | R |
| UMK105 CG361JV-F | | | CG | C0G | 360 p | ±5% | 1000 | 200 | 0.5±0.05 | R |
| UMK105 CG391JV-F | | | CG | C0G | 390 p | ±5% | 1000 | 200 | 0.5±0.05 | R |
| UMK105 CG431JV-F | | | CG | C0G | 430 p | ±5% | 1000 | 200 | 0.5±0.05 | R |
| UMK105 CG471JV-F | | | CG | C0G | 470 p | ±5% | 1000 | 200 | 0.5±0.05 | R |
| UMK105 CG511JV-F | | | CG | C0G | 510 p | ±5% | 1000 | 200 | 0.5±0.05 | R |
| UMK105 CG561JV-F | | | CG | C0G | 560 p | ±5% | 1000 | 200 | 0.5±0.05 | R |
| UMK105 CG621JV-F | | | CG | C0G | 620 p | ±5% | 1000 | 200 | 0.5±0.05 | R |
| UMK105 CG681JV-F | | | CG | C0G | 680 p | ±5% | 1000 | 200 | 0.5±0.05 | R |
| UMK105 CG751JV-F | | | CG | C0G | 750 p | ±5% | 1000 | 200 | 0.5±0.05 | R |
| UMK105 CG821JV-F | | | CG | C0G | 820 p | ±5% | 1000 | 200 | 0.5±0.05 | R |
| UMK105 CG102JV-F | | | CG | C0G | 1000 p | ±5% | 1000 | 200 | 0.5±0.05 | R |

[Temperature Characteristic CΔ : CΔ/C0Δ] 0.5mm thickness(V)

| Part number 1 | Part number 2 | Rated voltage [V] | Temperature characteristics | | Capacitance [F] | Capacitance tolerance [%] | Q (at 1MHz) min | HTLT | Thickness*3 [mm] | Soldering R:Reflow W:Wave |
|------------------|---------------|-------------------|-----------------------------|-----|-----------------|---------------------------|-----------------|-------------------|------------------|---------------------------|
| | | | | | | | | Rated voltage x % | | |
| UMK105 CK0R5CV-F | | 50 | CK | C0K | 0.5 p | ±0.25pF | 410 | 200 | 0.5±0.05 | R |
| UMK105 CK010CV-F | | | CK | C0K | 1 p | ±0.25pF | 420 | 200 | 0.5±0.05 | R |
| UMK105 CK1R5CV-F | | | CK | C0K | 1.5 p | ±0.25pF | 430 | 200 | 0.5±0.05 | R |
| UMK105 CK020CV-F | | | CK | C0K | 2 p | ±0.25pF | 440 | 200 | 0.5±0.05 | R |
| UMK105 CJ030CV-F | | | CJ | C0J | 3 p | ±0.25pF | 460 | 200 | 0.5±0.05 | R |
| UMK105 CH040CV-F | | | CH | C0H | 4 p | ±0.25pF | 480 | 200 | 0.5±0.05 | R |
| UMK105 CH050CV-F | | | CH | C0H | 5 p | ±0.25pF | 500 | 200 | 0.5±0.05 | R |
| UMK105 CH060DV-F | | | CH | C0H | 6 p | ±0.5pF | 520 | 200 | 0.5±0.05 | R |
| UMK105 CH070DV-F | | | CH | C0H | 7 p | ±0.5pF | 540 | 200 | 0.5±0.05 | R |
| UMK105 CH080DV-F | | | CH | C0H | 8 p | ±0.5pF | 560 | 200 | 0.5±0.05 | R |
| UMK105 CH090DV-F | | | CH | C0H | 9 p | ±0.5pF | 580 | 200 | 0.5±0.05 | R |
| UMK105 CH100DV-F | | | CH | C0H | 10 p | ±0.5pF | 600 | 200 | 0.5±0.05 | R |
| UMK105 CH120JV-F | | | CH | C0H | 12 p | ±5% | 640 | 200 | 0.5±0.05 | R |
| UMK105 CH150JV-F | | | CH | C0H | 15 p | ±5% | 700 | 200 | 0.5±0.05 | R |
| UMK105 CH180JV-F | | | CH | C0H | 18 p | ±5% | 760 | 200 | 0.5±0.05 | R |
| UMK105 CH220JV-F | | | CH | C0H | 22 p | ±5% | 840 | 200 | 0.5±0.05 | R |
| UMK105 CH270JV-F | | | CH | C0H | 27 p | ±5% | 940 | 200 | 0.5±0.05 | R |
| UMK105 CH330JV-F | | | CH | C0H | 33 p | ±5% | 1000 | 200 | 0.5±0.05 | R |
| UMK105 CH390JV-F | | | CH | C0H | 39 p | ±5% | 1000 | 200 | 0.5±0.05 | R |
| UMK105 CH470JV-F | | | CH | C0H | 47 p | ±5% | 1000 | 200 | 0.5±0.05 | R |
| UMK105 CH560JV-F | | | CH | C0H | 56 p | ±5% | 1000 | 200 | 0.5±0.05 | R |
| UMK105 CH680JV-F | | | CH | C0H | 68 p | ±5% | 1000 | 200 | 0.5±0.05 | R |
| UMK105 CH820JV-F | | | CH | C0H | 82 p | ±5% | 1000 | 200 | 0.5±0.05 | R |
| UMK105 CH101JV-F | | | CH | C0H | 100 p | ±5% | 1000 | 200 | 0.5±0.05 | R |
| UMK105 CH121JV-F | | | CH | C0H | 120 p | ±5% | 1000 | 200 | 0.5±0.05 | R |
| UMK105 CH151JV-F | | | CH | C0H | 150 p | ±5% | 1000 | 200 | 0.5±0.05 | R |
| UMK105 CH181JV-F | | | CH | C0H | 180 p | ±5% | 1000 | 200 | 0.5±0.05 | R |
| UMK105 CH221JV-F | | | CH | C0H | 220 p | ±5% | 1000 | 200 | 0.5±0.05 | R |
| UMK105 CH271JV-F | | | CH | C0H | 270 p | ±5% | 1000 | 200 | 0.5±0.05 | R |
| UMK105 CH331JV-F | | | CH | C0H | 330 p | ±5% | 1000 | 200 | 0.5±0.05 | R |
| UMK105 CH361JV-F | | | CH | C0H | 360 p | ±5% | 1000 | 200 | 0.5±0.05 | R |
| UMK105 CH391JV-F | | | CH | C0H | 390 p | ±5% | 1000 | 200 | 0.5±0.05 | R |
| UMK105 CH431JV-F | | | CH | C0H | 430 p | ±5% | 1000 | 200 | 0.5±0.05 | R |
| UMK105 CH471JV-F | | | CH | C0H | 470 p | ±5% | 1000 | 200 | 0.5±0.05 | R |
| UMK105 CH511JV-F | | | CH | C0H | 510 p | ±5% | 1000 | 200 | 0.5±0.05 | R |
| UMK105 CH561JV-F | | | CH | C0H | 560 p | ±5% | 1000 | 200 | 0.5±0.05 | R |
| UMK105 CH621JV-F | | | CH | C0H | 620 p | ±5% | 1000 | 200 | 0.5±0.05 | R |
| UMK105 CH681JV-F | | | CH | C0H | 680 p | ±5% | 1000 | 200 | 0.5±0.05 | R |
| UMK105 CH751JV-F | | | CH | C0H | 750 p | ±5% | 1000 | 200 | 0.5±0.05 | R |
| UMK105 CH821JV-F | | | CH | C0H | 820 p | ±5% | 1000 | 200 | 0.5±0.05 | R |
| UMK105 CH102JV-F | | | CH | C0H | 1000 p | ±5% | 1000 | 200 | 0.5±0.05 | R |

▶ This catalog contains the typical specification only due to the limitation of space. When you consider the purchase of our products, please check our specification. For details of each product (characteristics graph, reliability information, precautions for use, and so on), see our Web site (<http://www.ty-top.com/>).

[Temperature Characteristic UΔ : UΔ/U2Δ] 0.5mm thickness(V)

| Part number 1 | Part number 2 | Rated voltage [V] | Temperature characteristics | | Capacitance [F] | Capacitance tolerance [%] | Q (at 1MHz) min | HTLT | Thickness*3 [mm] | Soldering R:Reflow W:Wave |
|------------------|---------------|-------------------|-----------------------------|-----|-----------------|---------------------------|-----------------|-------------------|------------------|---------------------------|
| | | | | | | | | Rated voltage x % | | |
| UMK105 UK0R5CV-F | | 50 | UK | U2K | 0.5 p | ±0.25pF | 410 | 200 | 0.5±0.05 | R |
| UMK105 UK010CV-F | | | UK | U2K | 1 p | ±0.25pF | 420 | 200 | 0.5±0.05 | R |
| UMK105 UK1R5CV-F | | | UK | U2K | 1.5 p | ±0.25pF | 430 | 200 | 0.5±0.05 | R |
| UMK105 UK020CV-F | | | UK | U2K | 2 p | ±0.25pF | 440 | 200 | 0.5±0.05 | R |
| UMK105 UK030CV-F | | | UK | U2K | 3 p | ±0.25pF | 460 | 200 | 0.5±0.05 | R |
| UMK105 UJ040CV-F | | | UJ | U2J | 4 p | ±0.25pF | 480 | 200 | 0.5±0.05 | R |
| UMK105 UJ050CV-F | | | UJ | U2J | 5 p | ±0.25pF | 500 | 200 | 0.5±0.05 | R |
| UMK105 UJ060DV-F | | | UJ | U2J | 6 p | ±0.5pF | 520 | 200 | 0.5±0.05 | R |
| UMK105 UJ070DV-F | | | UJ | U2J | 7 p | ±0.5pF | 540 | 200 | 0.5±0.05 | R |
| UMK105 UJ080DV-F | | | UJ | U2J | 8 p | ±0.5pF | 560 | 200 | 0.5±0.05 | R |
| UMK105 UJ090DV-F | | | UJ | U2J | 9 p | ±0.5pF | 580 | 200 | 0.5±0.05 | R |
| UMK105 UJ100DV-F | | | UJ | U2J | 10 p | ±0.5pF | 600 | 200 | 0.5±0.05 | R |
| UMK105 UJ120JV-F | | | UJ | U2J | 12 p | ±5% | 640 | 200 | 0.5±0.05 | R |
| UMK105 UJ150JV-F | | | UJ | U2J | 15 p | ±5% | 700 | 200 | 0.5±0.05 | R |
| UMK105 UJ180JV-F | | | UJ | U2J | 18 p | ±5% | 760 | 200 | 0.5±0.05 | R |
| UMK105 UJ220JV-F | | | UJ | U2J | 22 p | ±5% | 840 | 200 | 0.5±0.05 | R |
| UMK105 UJ270JV-F | | | UJ | U2J | 27 p | ±5% | 940 | 200 | 0.5±0.05 | R |
| UMK105 UJ330JV-F | | | UJ | U2J | 33 p | ±5% | 1000 | 200 | 0.5±0.05 | R |
| UMK105 UJ390JV-F | | | UJ | U2J | 39 p | ±5% | 1000 | 200 | 0.5±0.05 | R |
| UMK105 UJ470JV-F | | | UJ | U2J | 47 p | ±5% | 1000 | 200 | 0.5±0.05 | R |
| UMK105 UJ560JV-F | | | UJ | U2J | 56 p | ±5% | 1000 | 200 | 0.5±0.05 | R |
| UMK105 UJ680JV-F | | | UJ | U2J | 68 p | ±5% | 1000 | 200 | 0.5±0.05 | R |
| UMK105 UJ820JV-F | | | UJ | U2J | 82 p | ±5% | 1000 | 200 | 0.5±0.05 | R |
| UMK105 UJ101JV-F | | | UJ | U2J | 100 p | ±5% | 1000 | 200 | 0.5±0.05 | R |
| UMK105 UJ121JV-F | | | UJ | U2J | 120 p | ±5% | 1000 | 200 | 0.5±0.05 | R |
| UMK105 UJ151JV-F | | | UJ | U2J | 150 p | ±5% | 1000 | 200 | 0.5±0.05 | R |
| UMK105 UJ181JV-F | | | UJ | U2J | 180 p | ±5% | 1000 | 200 | 0.5±0.05 | R |
| UMK105 UJ221JV-F | | | UJ | U2J | 220 p | ±5% | 1000 | 200 | 0.5±0.05 | R |
| UMK105 UJ271JV-F | | | UJ | U2J | 270 p | ±5% | 1000 | 200 | 0.5±0.05 | R |
| UMK105 UJ331JV-F | | | UJ | U2J | 330 p | ±5% | 1000 | 200 | 0.5±0.05 | R |

[Temperature Characteristic SL] 0.5mm thickness(V)

| Part number 1 | Part number 2 | Rated voltage [V] | Temperature characteristics | | Capacitance [F] | Capacitance tolerance [%] | Q (at 1MHz) min | HTLT | Thickness*3 [mm] | Soldering R:Reflow W:Wave |
|------------------|---------------|-------------------|-----------------------------|--|-----------------|---------------------------|-----------------|-------------------|------------------|---------------------------|
| | | | | | | | | Rated voltage x % | | |
| UMK105 SL121JV-F | | 50 | SL | | 120 p | ±5% | 1000 | 200 | 0.5±0.05 | R |
| UMK105 SL151JV-F | | | SL | | 150 p | ±5% | 1000 | 200 | 0.5±0.05 | R |
| UMK105 SL181JV-F | | | SL | | 180 p | ±5% | 1000 | 200 | 0.5±0.05 | R |
| UMK105 SL221JV-F | | | SL | | 220 p | ±5% | 1000 | 200 | 0.5±0.05 | R |
| UMK105 SL271JV-F | | | SL | | 270 p | ±5% | 1000 | 200 | 0.5±0.05 | R |
| UMK105 SL331JV-F | | | SL | | 330 p | ±5% | 1000 | 200 | 0.5±0.05 | R |

Multilayer Ceramic Capacitors for High Frequency Applications (1GHz+)

042TYPE

[Temperature Characteristic CH : CH/COH] 0.2mm thickness(C)

| Part number 1 | Part number 2 | Rated voltage [V] | Temperature characteristics | | Capacitance [F] | Capacitance tolerance [%] | Q (at 1GHz) (min) | HTLT | Thickness*3 [mm] | Soldering R:Reflow W:Wave |
|------------------|---------------|-------------------|-----------------------------|------|-----------------|---------------------------|-------------------|-------------------|------------------|---------------------------|
| | | | | | | | | Rated voltage x % | | |
| TVS042 CH0R2□C-W | | 25 | CH | COH | 0.2 p | ±0.1pF, 0.25pF | 300 | 200 | 0.2±0.02 | R |
| TVS042 CH0R3□C-W | | | CH | COH | 0.3 p | ±0.1pF, 0.25pF | 300 | 200 | 0.2±0.02 | R |
| TVS042 CH0R4□C-W | | | CH | COH | 0.4 p | ±0.1pF, 0.25pF | 300 | 200 | 0.2±0.02 | R |
| TVS042 CH0R5□C-W | | | CH | COH | 0.5 p | ±0.1pF, 0.25pF | 300 | 200 | 0.2±0.02 | R |
| TVS042 CH0R6□C-W | | | CH | COH | 0.6 p | ±0.1pF, 0.25pF | 300 | 200 | 0.2±0.02 | R |
| TVS042 CH0R7□C-W | | | CH | COH | 0.7 p | ±0.1pF, 0.25pF | 300 | 200 | 0.2±0.02 | R |
| TVS042 CHR75□C-W | | | CH | COH | 0.75 p | ±0.1pF, 0.25pF | 300 | 200 | 0.2±0.02 | R |
| TVS042 CH0R8□C-W | | | CH | COH | 0.8 p | ±0.1pF, 0.25pF | 300 | 200 | 0.2±0.02 | R |
| TVS042 CH0R9□C-W | | | CH | COH | 0.9 p | ±0.1pF, 0.25pF | 300 | 200 | 0.2±0.02 | R |
| TVS042 CH010□C-W | | | CH | COH | 1 p | ±0.1pF, 0.25pF | 300 | 200 | 0.2±0.02 | R |
| TVS042 CH1R1□C-W | | | CH | COH | 1.1 p | ±0.1pF, 0.25pF | 280 | 200 | 0.2±0.02 | R |
| TVS042 CH1R2□C-W | | | CH | COH | 1.2 p | ±0.1pF, 0.25pF | 270 | 200 | 0.2±0.02 | R |
| TVS042 CH1R3□C-W | | | CH | COH | 1.3 p | ±0.1pF, 0.25pF | 260 | 200 | 0.2±0.02 | R |
| TVS042 CH1R5□C-W | | | CH | COH | 1.5 p | ±0.1pF, 0.25pF | 240 | 200 | 0.2±0.02 | R |
| TVS042 CH1R6□C-W | | | CH | COH | 1.6 p | ±0.1pF, 0.25pF | 230 | 200 | 0.2±0.02 | R |
| TVS042 CH1R8□C-W | | | CH | COH | 1.8 p | ±0.1pF, 0.25pF | 210 | 200 | 0.2±0.02 | R |
| TVS042 CH020□C-W | | | CH | COH | 2 p | ±0.1pF, 0.25pF | 190 | 200 | 0.2±0.02 | R |
| TVS042 CH2R2□C-W | | | CH | COH | 2.2 p | ±0.1pF, 0.25pF | 180 | 200 | 0.2±0.02 | R |
| TVS042 CH2R4□C-W | | | CH | COH | 2.4 p | ±0.1pF, 0.25pF | 170 | 200 | 0.2±0.02 | R |
| TVS042 CH2R7□C-W | | | CH | COH | 2.7 p | ±0.1pF, 0.25pF | 150 | 200 | 0.2±0.02 | R |
| TVS042 CH030□C-W | | | CH | COH | 3 p | ±0.1pF, 0.25pF | 130 | 200 | 0.2±0.02 | R |
| TVS042 CH3R3□C-W | | | CH | COH | 3.3 p | ±0.1pF, 0.25pF | 120 | 200 | 0.2±0.02 | R |
| TVS042 CH3R6□C-W | | | CH | COH | 3.6 p | ±0.1pF, 0.25pF | 110 | 200 | 0.2±0.02 | R |
| TVS042 CH3R9□C-W | | | CH | COH | 3.9 p | ±0.1pF, 0.25pF | 100 | 200 | 0.2±0.02 | R |
| TVS042 CH040□C-W | | | CH | COH | 4 p | ±0.1pF, 0.25pF | 90 | 200 | 0.2±0.02 | R |
| TVS042 CH4R3□C-W | | | CH | COH | 4.3 p | ±0.1pF, 0.25pF | 85 | 200 | 0.2±0.02 | R |
| TVS042 CH4R7□C-W | | | CH | COH | 4.7 p | ±0.1pF, 0.25pF | 85 | 200 | 0.2±0.02 | R |
| TVS042 CH050□C-W | | | CH | COH | 5 p | ±0.1pF, 0.25pF | 80 | 200 | 0.2±0.02 | R |
| TVS042 CH5R1□C-W | | | CH | COH | 5.1 p | ±0.25pF, 0.5pF | 75 | 200 | 0.2±0.02 | R |
| TVS042 CH5R6□C-W | | | CH | COH | 5.6 p | ±0.25pF, 0.5pF | 70 | 200 | 0.2±0.02 | R |
| TVS042 CH060□C-W | | | CH | COH | 6 p | ±0.25pF, 0.5pF | 65 | 200 | 0.2±0.02 | R |
| TVS042 CH6R2□C-W | | | CH | COH | 6.2 p | ±0.25pF, 0.5pF | 65 | 200 | 0.2±0.02 | R |
| TVS042 CH6R8□C-W | | | CH | COH | 6.8 p | ±0.25pF, 0.5pF | 60 | 200 | 0.2±0.02 | R |
| TVS042 CH070□C-W | | | CH | COH | 7 p | ±0.25pF, 0.5pF | 60 | 200 | 0.2±0.02 | R |
| TVS042 CH7R5□C-W | | | CH | COH | 7.5 p | ±0.25pF, 0.5pF | 55 | 200 | 0.2±0.02 | R |
| TVS042 CH080□C-W | | | CH | COH | 8 p | ±0.25pF, 0.5pF | 55 | 200 | 0.2±0.02 | R |
| TVS042 CH8R2□C-W | | | CH | COH | 8.2 p | ±0.25pF, 0.5pF | 50 | 200 | 0.2±0.02 | R |
| TVS042 CH090□C-W | | | CH | COH | 9 p | ±0.25pF, 0.5pF | 50 | 200 | 0.2±0.02 | R |
| TVS042 CH9R1□C-W | | | CH | COH | 9.1 p | ±0.25pF, 0.5pF | 45 | 200 | 0.2±0.02 | R |
| TVS042 CH100□C-W | | | CH | COH | 10 p | ±2%, ±5% | 45 | 200 | 0.2±0.02 | R |
| TVS042 CH110JC-W | | CH | COH | 11 p | ±5% | 40 | 200 | 0.2±0.02 | R | |
| TVS042 CH120JC-W | | CH | COH | 12 p | ±5% | 40 | 200 | 0.2±0.02 | R | |

▶ This catalog contains the typical specification only due to the limitation of space. When you consider the purchase of our products, please check our specification. For details of each product (characteristics graph, reliability information, precautions for use, and so on), see our Web site (<http://www.ty-top.com/>).

■ PARTS NUMBER

| Part number 1 | Part number 2 | Rated voltage [V] | Temperature characteristics | | Capacitance [F] | Capacitance tolerance [%] | Q (at 1GHz) (min) | HTLT | Thickness*3 [mm] | Soldering R:Reflow W:Wave |
|------------------|---------------|-------------------|-----------------------------|-----|-----------------|---------------------------|-------------------|-------------------|------------------|---------------------------|
| | | | | | | | | Rated voltage x % | | |
| TVS042 CH130JC-W | | 25 | CH | C0H | 13 p | ±5% | 40 | 200 | 0.2±0.02 | R |
| TVS042 CH150JC-W | | | CH | C0H | 15 p | ±5% | 40 | 200 | 0.2±0.02 | R |
| TVS042 CH160JC-W | | | CH | C0H | 16 p | ±5% | 40 | 200 | 0.2±0.02 | R |
| TVS042 CH180JC-W | | | CH | C0H | 18 p | ±5% | 40 | 200 | 0.2±0.02 | R |
| TVS042 CH220JC-W | | | CH | C0H | 22 p | ±5% | 30 | 200 | 0.2±0.02 | R |

● 105TYPE

[Temperature Characteristic CH : CH/C0H] 0.5mm thickness(W)

| Part number 1 | Part number 2 | Rated voltage [V] | Temperature characteristics | | Capacitance [F] | Capacitance tolerance [%] | Q (at 1GHz) (min) | HTLT | Thickness*3 [mm] | Soldering R:Reflow W:Wave |
|------------------|---------------|-------------------|-----------------------------|-----|-----------------|---------------------------|-------------------|-------------------|------------------|---------------------------|
| | | | | | | | | Rated voltage x % | | |
| EVK105 CH0R3BW-F | | 16 | CH | C0H | 0.3 p | ±0.1pF | 300 | 200 | 0.5±0.05 | R |
| EVK105 CH0R4BW-F | | | CH | C0H | 0.4 p | ±0.1pF | 300 | 200 | 0.5±0.05 | R |
| EVK105 CH0R5BW-F | | | CH | C0H | 0.5 p | ±0.1pF | 300 | 200 | 0.5±0.05 | R |
| EVK105 CH0R6BW-F | | | CH | C0H | 0.6 p | ±0.1pF | 300 | 200 | 0.5±0.05 | R |
| EVK105 CH0R7BW-F | | | CH | C0H | 0.7 p | ±0.1pF | 300 | 200 | 0.5±0.05 | R |
| EVK105 CH0R8BW-F | | | CH | C0H | 0.8 p | ±0.1pF | 300 | 200 | 0.5±0.05 | R |
| EVK105 CH0R9BW-F | | | CH | C0H | 0.9 p | ±0.1pF | 300 | 200 | 0.5±0.05 | R |
| EVK105 CH010BW-F | | | CH | C0H | 1 p | ±0.1pF | 300 | 200 | 0.5±0.05 | R |
| EVK105 CH1R1BW-F | | | CH | C0H | 1.1 p | ±0.1pF | 280 | 200 | 0.5±0.05 | R |
| EVK105 CH1R2BW-F | | | CH | C0H | 1.2 p | ±0.1pF | 270 | 200 | 0.5±0.05 | R |
| EVK105 CH1R3BW-F | | | CH | C0H | 1.3 p | ±0.1pF | 260 | 200 | 0.5±0.05 | R |
| EVK105 CH1R5BW-F | | | CH | C0H | 1.5 p | ±0.1pF | 240 | 200 | 0.5±0.05 | R |
| EVK105 CH1R6BW-F | | | CH | C0H | 1.6 p | ±0.1pF | 230 | 200 | 0.5±0.05 | R |
| EVK105 CH1R8BW-F | | | CH | C0H | 1.8 p | ±0.1pF | 210 | 200 | 0.5±0.05 | R |
| EVK105 CH020BW-F | | | CH | C0H | 2 p | ±0.1pF | 190 | 200 | 0.5±0.05 | R |
| EVK105 CH2R2JW-F | | | CH | C0H | 2.2 p | ±5% | 180 | 200 | 0.5±0.05 | R |
| EVK105 CH2R4JW-F | | | CH | C0H | 2.4 p | ±5% | 170 | 200 | 0.5±0.05 | R |
| EVK105 CH2R7JW-F | | | CH | C0H | 2.7 p | ±5% | 150 | 200 | 0.5±0.05 | R |
| EVK105 CH030JW-F | | | CH | C0H | 3 p | ±5% | 130 | 200 | 0.5±0.05 | R |
| EVK105 CH3R3JW-F | | | CH | C0H | 3.3 p | ±5% | 120 | 200 | 0.5±0.05 | R |
| EVK105 CH3R6JW-F | | | CH | C0H | 3.6 p | ±5% | 110 | 200 | 0.5±0.05 | R |
| EVK105 CH3R9JW-F | | | CH | C0H | 3.9 p | ±5% | 99 | 200 | 0.5±0.05 | R |
| EVK105 CH4R3JW-F | | | CH | C0H | 4.3 p | ±5% | 84 | 200 | 0.5±0.05 | R |
| EVK105 CH4R7JW-F | | | CH | C0H | 4.7 p | ±5% | 84 | 200 | 0.5±0.05 | R |
| EVK105 CH5R1JW-F | | | CH | C0H | 5.1 p | ±5% | 84 | 200 | 0.5±0.05 | R |

[Temperature Characteristic CH : CH/C0H] 0.5mm thickness(W)

| Part number 1 | Part number 2 | Rated voltage [V] | Temperature characteristics | | Capacitance [F] | Capacitance tolerance [%] | Q (at 1GHz) (min) | HTLT | Thickness*3 [mm] | Soldering R:Reflow W:Wave |
|------------------|---------------|-------------------|-----------------------------|-----|-----------------|---------------------------|-------------------|-------------------|------------------|---------------------------|
| | | | | | | | | Rated voltage x % | | |
| UVK105 CH0R3BW-F | | 50 | CH | C0H | 0.3 p | ±0.1pF | 300 | 200 | 0.5±0.05 | R |
| UVK105 CH0R4BW-F | | | CH | C0H | 0.4 p | ±0.1pF | 300 | 200 | 0.5±0.05 | R |
| UVK105 CH0R5BW-F | | | CH | C0H | 0.5 p | ±0.1pF | 300 | 200 | 0.5±0.05 | R |
| UVK105 CH0R6BW-F | | | CH | C0H | 0.6 p | ±0.1pF | 300 | 200 | 0.5±0.05 | R |
| UVK105 CH0R7BW-F | | | CH | C0H | 0.7 p | ±0.1pF | 300 | 200 | 0.5±0.05 | R |
| UVK105 CH0R8BW-F | | | CH | C0H | 0.8 p | ±0.1pF | 300 | 200 | 0.5±0.05 | R |
| UVK105 CH0R9BW-F | | | CH | C0H | 0.9 p | ±0.1pF | 300 | 200 | 0.5±0.05 | R |
| UVK105 CH010BW-F | | | CH | C0H | 1 p | ±0.1pF | 300 | 200 | 0.5±0.05 | R |
| UVK105 CH1R1BW-F | | | CH | C0H | 1.1 p | ±0.1pF | 280 | 200 | 0.5±0.05 | R |
| UVK105 CH1R2BW-F | | | CH | C0H | 1.2 p | ±0.1pF | 270 | 200 | 0.5±0.05 | R |
| UVK105 CH1R3BW-F | | | CH | C0H | 1.3 p | ±0.1pF | 260 | 200 | 0.5±0.05 | R |
| UVK105 CH1R5BW-F | | | CH | C0H | 1.5 p | ±0.1pF | 240 | 200 | 0.5±0.05 | R |
| UVK105 CH1R6BW-F | | | CH | C0H | 1.6 p | ±0.1pF | 230 | 200 | 0.5±0.05 | R |
| UVK105 CH1R8BW-F | | | CH | C0H | 1.8 p | ±0.1pF | 210 | 200 | 0.5±0.05 | R |
| UVK105 CH020BW-F | | | CH | C0H | 2 p | ±0.1pF | 190 | 200 | 0.5±0.05 | R |
| UVK105 CH2R2JW-F | | | CH | C0H | 2.2 p | ±5% | 180 | 200 | 0.5±0.05 | R |
| UVK105 CH2R4JW-F | | | CH | C0H | 2.4 p | ±5% | 170 | 200 | 0.5±0.05 | R |
| UVK105 CH2R7JW-F | | | CH | C0H | 2.7 p | ±5% | 150 | 200 | 0.5±0.05 | R |
| UVK105 CH030JW-F | | | CH | C0H | 3 p | ±5% | 130 | 200 | 0.5±0.05 | R |
| UVK105 CH3R3JW-F | | | CH | C0H | 3.3 p | ±5% | 120 | 200 | 0.5±0.05 | R |
| UVK105 CH3R6JW-F | | | CH | C0H | 3.6 p | ±5% | 110 | 200 | 0.5±0.05 | R |
| UVK105 CH3R9JW-F | | | CH | C0H | 3.9 p | ±5% | 99 | 200 | 0.5±0.05 | R |
| UVK105 CH4R3JW-F | | | CH | C0H | 4.3 p | ±5% | 84 | 200 | 0.5±0.05 | R |
| UVK105 CH4R7JW-F | | | CH | C0H | 4.7 p | ±5% | 84 | 200 | 0.5±0.05 | R |
| UVK105 CH5R1JW-F | | | CH | C0H | 5.1 p | ±5% | 84 | 200 | 0.5±0.05 | R |

Super Low Distortion Multilayer Ceramic Capacitors (GFCAP™)

● 105TYPE

[Temperature Characteristic SD : Standard] 0.5mm thickness(V)

| Part number 1 | Part number 2 | Rated voltage [V] | Temperature characteristics | Capacitance [F] | Capacitance tolerance [%] | tan δ [%] | HTLT | Thickness*3 [mm] | Soldering R:Reflow W:Wave |
|------------------|---------------|-------------------|-----------------------------|-----------------|---------------------------|-----------|-------------------|------------------|---------------------------|
| | | | | | | | Rated voltage x % | | |
| UMK105 SD391KV-F | | 50 | Standard Type | 390 p | ±10 | 0.1 | 200 | 0.5±0.05 | R |
| UMK105 SD471KV-F | | | | 470 p | ±10 | 0.1 | 200 | 0.5±0.05 | R |
| UMK105 SD561KV-F | | | | 560 p | ±10 | 0.1 | 200 | 0.5±0.05 | R |
| TMK105 SD681KV-F | | 25 | | 680 p | ±10 | 0.1 | 200 | 0.5±0.05 | R |
| TMK105 SD821KV-F | | | | 820 p | ±10 | 0.1 | 200 | 0.5±0.05 | R |
| TMK105 SD102KV-F | | | | 1000 p | ±10 | 0.1 | 200 | 0.5±0.05 | R |
| TMK105 SD122KV-F | | 16 | | 1200 p | ±10 | 0.1 | 200 | 0.5±0.05 | R |
| EMK105 SD152KV-F | | | | 1500 p | ±10 | 0.1 | 200 | 0.5±0.05 | R |
| EMK105 SD182KV-F | | | | 1800 p | ±10 | 0.1 | 200 | 0.5±0.05 | R |
| EMK105 SD222KV-F | | 10 | | 2200 p | ±10 | 0.1 | 200 | 0.5±0.05 | R |
| EMK105 SD272KV-F | | | | 2700 p | ±10 | 0.1 | 200 | 0.5±0.05 | R |
| LMK105 SD332KV-F | | | | 3300 p | ±10 | 0.1 | 200 | 0.5±0.05 | R |
| LMK105 SD392KV-F | | 10 | | 3900 p | ±10 | 0.1 | 200 | 0.5±0.05 | R |
| LMK105 SD472KV-F | | | | 4700 p | ±10 | 0.1 | 200 | 0.5±0.05 | R |

▶ This catalog contains the typical specification only due to the limitation of space. When you consider the purchase of our products, please check our specification. For details of each product (characteristics graph, reliability information, precautions for use, and so on), see our Web site (<http://www.ty-top.com/>).

■ PARTS NUMBER

[Temperature Characteristic SD : Standard] 0.3mm thickness (P)

| Part number 1 | Part number 2 | Rated voltage [V] | Temperature characteristics | Capacitance [F] | Capacitance tolerance [%] | tan δ [%] | HTLT | Thickness* ³ [mm] | Soldering R:Reflow W:Wave |
|------------------|---------------|-------------------|-----------------------------|-----------------|---------------------------|-----------|-------------------|------------------------------|---------------------------|
| | | | | | | | Rated voltage x % | | |
| LMK105 SD152KP-F | | 10 | Standard Type | 1500 p | ±10 | 0.1 | 200 | 0.3±0.03 | R |
| JMK105 SD272KP-F | | 6.3 | | 2700 p | ±10 | 0.1 | 200 | 0.3±0.03 | R |

● 107TYPE

[Temperature Characteristic SD : Standard] 0.8mm thickness (A)

| Part number 1 | Part number 2 | Rated voltage [V] | Temperature characteristics | Capacitance [F] | Capacitance tolerance [%] | tan δ [%] | HTLT | Thickness* ³ [mm] | Soldering R:Reflow W:Wave |
|------------------|---------------|-------------------|-----------------------------|-----------------|---------------------------|-----------|-------------------|------------------------------|---------------------------|
| | | | | | | | Rated voltage x % | | |
| UMK107 SD102KA-T | | 50 | Standard Type | 1000 p | ±10 | 0.1 | 200 | 0.8±0.10 | R |
| UMK107 SD122KA-T | | | | 1200 p | ±10 | 0.1 | 200 | 0.8±0.10 | R |
| UMK107 SD152KA-T | | | | 1500 p | ±10 | 0.1 | 200 | 0.8±0.10 | R |
| UMK107 SD182KA-T | | | | 1800 p | ±10 | 0.1 | 200 | 0.8±0.10 | R |
| UMK107 SD222KA-T | | | | 2200 p | ±10 | 0.1 | 200 | 0.8±0.10 | R |
| UMK107 SD272KA-T | | | | 2700 p | ±10 | 0.1 | 200 | 0.8±0.10 | R |
| UMK107 SD332KA-T | | 25 | Standard Type | 3300 p | ±10 | 0.1 | 200 | 0.8±0.10 | R |
| TMK107 SD392KA-T | | | | 3900 p | ±10 | 0.1 | 200 | 0.8±0.10 | R |
| TMK107 SD472KA-T | | | | 4700 p | ±10 | 0.1 | 200 | 0.8±0.10 | R |
| EMK107 SD562KA-T | | 16 | Standard Type | 5600 p | ±10 | 0.1 | 200 | 0.8±0.10 | R |
| EMK107 SD682KA-T | | | | 6800 p | ±10 | 0.1 | 200 | 0.8±0.10 | R |
| EMK107 SD822KA-T | | | | 8200 p | ±10 | 0.1 | 200 | 0.8±0.10 | R |
| EMK107 SD103KA-T | | | | 10000 p | ±10 | 0.1 | 200 | 0.8±0.10 | R |
| LMK107 SD123KA-T | | 10 | Standard Type | 12000 p | ±10 | 0.1 | 200 | 0.8±0.10 | R |
| LMK107 SD153KA-T | | | | 15000 p | ±10 | 0.1 | 200 | 0.8±0.10 | R |
| LMK107 SD183KA-T | | | | 18000 p | ±10 | 0.1 | 200 | 0.8±0.10 | R |
| LMK107 SD223KA-T | | | | 22000 p | ±10 | 0.1 | 200 | 0.8±0.10 | R |

● 212TYPE

[Temperature Characteristic SD : Standard] 1.25mm thickness (G)

| Part number 1 | Part number 2 | Rated voltage [V] | Temperature characteristics | Capacitance [F] | Capacitance tolerance [%] | tan δ [%] | HTLT | Thickness* ³ [mm] | Soldering R:Reflow W:Wave |
|------------------|---------------|-------------------|-----------------------------|-----------------|---------------------------|-----------|-------------------|------------------------------|---------------------------|
| | | | | | | | Rated voltage x % | | |
| GMK212 SD183KG-T | | 35 | Standard Type | 18000 p | ±10 | 0.1 | 200 | 1.25±0.10 | R |
| GMK212 SD223KG-T | | | | 22000 p | ±10 | 0.1 | 200 | 1.25±0.10 | R |
| GMK212 SD273KG-T | | | | 27000 p | ±10 | 0.1 | 200 | 1.25±0.10 | R |
| LMK212 SD683KG-T | | 10 | Standard Type | 68000 p | ±10 | 0.1 | 200 | 1.25±0.10 | R |
| LMK212 SD823KG-T | | | | 82000 p | ±10 | 0.1 | 200 | 1.25±0.10 | R |
| LMK212 SD104KG-T | | | | 0.1 μ | ±10 | 0.1 | 200 | 1.25±0.10 | R |

[Temperature Characteristic SD : Standard] 0.85mm thickness (D)

| Part number 1 | Part number 2 | Rated voltage [V] | Temperature characteristics | Capacitance [F] | Capacitance tolerance [%] | tan δ [%] | HTLT | Thickness* ³ [mm] | Soldering R:Reflow W:Wave |
|------------------|---------------|-------------------|-----------------------------|-----------------|---------------------------|-----------|-------------------|------------------------------|---------------------------|
| | | | | | | | Rated voltage x % | | |
| UMK212 SD392KD-T | | 50 | Standard Type | 3900 p | ±10 | 0.1 | 200 | 0.85±0.10 | R |
| UMK212 SD472KD-T | | | | 4700 p | ±10 | 0.1 | 200 | 0.85±0.10 | R |
| UMK212 SD562KD-T | | | | 5600 p | ±10 | 0.1 | 200 | 0.85±0.10 | R |
| UMK212 SD682KD-T | | | | 6800 p | ±10 | 0.1 | 200 | 0.85±0.10 | R |
| UMK212 SD822KD-T | | | | 8200 p | ±10 | 0.1 | 200 | 0.85±0.10 | R |
| UMK212 SD103KD-T | | | | 10000 p | ±10 | 0.1 | 200 | 0.85±0.10 | R |
| GMK212 SD123KD-T | | 35 | Standard Type | 12000 p | ±10 | 0.1 | 200 | 0.85±0.10 | R |
| GMK212 SD153KD-T | | | | 15000 p | ±10 | 0.1 | 200 | 0.85±0.10 | R |
| EMK212 SD333KD-T | | 16 | Standard Type | 33000 p | ±10 | 0.1 | 200 | 0.85±0.10 | R |
| LMK212 SD473KD-T | | 10 | | 47000 p | ±10 | 0.1 | 200 | 0.85±0.10 | R |

● 316TYPE

[Temperature Characteristic SD : Standard] 1.6mm thickness (L)

| Part number 1 | Part number 2 | Rated voltage [V] | Temperature characteristics | Capacitance [F] | Capacitance tolerance [%] | tan δ [%] | HTLT | Thickness* ³ [mm] | Soldering R:Reflow W:Wave |
|------------------|---------------|-------------------|-----------------------------|-----------------|---------------------------|-----------|-------------------|------------------------------|---------------------------|
| | | | | | | | Rated voltage x % | | |
| TMK316 SD823KL-T | | 25 | Standard Type | 82000 p | ±10 | 0.1 | 200 | 1.6±0.20 | R |
| TMK316 SD104KL-T | | | | 0.1 μ | ±10 | 0.1 | 200 | 1.6±0.20 | R |

[Temperature Characteristic SD : Standard] 1.15mm thickness (F)

| Part number 1 | Part number 2 | Rated voltage [V] | Temperature characteristics | Capacitance [F] | Capacitance tolerance [%] | tan δ [%] | HTLT | Thickness* ³ [mm] | Soldering R:Reflow W:Wave |
|------------------|---------------|-------------------|-----------------------------|-----------------|---------------------------|-----------|-------------------|------------------------------|---------------------------|
| | | | | | | | Rated voltage x % | | |
| GMK316 SD333KF-T | | 35 | Standard Type | 33000 p | ±10 | 0.1 | 200 | 1.15±0.10 | R |
| GMK316 SD393KF-T | | | | 39000 p | ±10 | 0.1 | 200 | 1.15±0.10 | R |
| TMK316 SD473KF-T | | 25 | Standard Type | 47000 p | ±10 | 0.1 | 200 | 1.15±0.10 | R |
| TMK316 SD563KF-T | | | | 56000 p | ±10 | 0.1 | 200 | 1.15±0.10 | R |
| TMK316 SD683KF-T | | | | 68000 p | ±10 | 0.1 | 200 | 1.15±0.10 | R |

Low Distortion High Value Multilayer Ceramic Capacitors(CF LD)

● 107TYPE

[Temperature Characteristic LD : X5R] 0.8mm thickness (A)

| Part number 1 | Part number 2 | Rated voltage [V] | Temperature characteristics | Capacitance [F] | Capacitance tolerance [%] | tan δ [%] | HTLT | Thickness* ³ [mm] | Soldering R:Reflow W:Wave |
|------------------|---------------|-------------------|-----------------------------|-----------------|---------------------------|-----------|-------------------|------------------------------|---------------------------|
| | | | | | | | Rated voltage x % | | |
| UMK107BLD224□A-T | | 50 | X5R | 0.22 μ | ±10, ±20 | 10 | 150 | 0.8+0.20/-0 | R |
| TMK107BLD474□A-T | | 25 | X5R | 0.47 μ | ±10, ±20 | 10 | 150 | 0.8+0.20/-0 | R |
| TMK107BLD105□A-T | | | X5R | 1 μ | ±10, ±20 | 10 | 150 | 0.8+0.20/-0 | R |

● 212TYPE

[Temperature Characteristic LD : X5R] 1.25mm thickness (G)

| Part number 1 | Part number 2 | Rated voltage [V] | Temperature characteristics | Capacitance [F] | Capacitance tolerance [%] | tan δ [%] | HTLT | Thickness* ³ [mm] | Soldering R:Reflow W:Wave |
|------------------|---------------|-------------------|-----------------------------|-----------------|---------------------------|-----------|-------------------|------------------------------|---------------------------|
| | | | | | | | Rated voltage x % | | |
| GMK212 LD105□G-T | | 35 | X5R | 1 μ | ±10, ±20 | 10 | 150 | 1.25±0.10 | R |
| GMK212BLD225□G-T | | | X5R | 2.2 μ | ±10, ±20 | 10 | 150 | 1.25+0.20/-0 | R |

▶ This catalog contains the typical specification only due to the limitation of space. When you consider the purchase of our products, please check our specification. For details of each product (characteristics graph, reliability information, precautions for use, and so on), see our Web site (<http://www.ty-top.com/>).

■ PARTS NUMBER

● 316TYPE

【Temperature Characteristic LD : X5R】 1.6mm thickness(L)

| Part number 1 | Part number 2 | Rated voltage [V] | Temperature characteristics | | Capacitance [F] | Capacitance tolerance [%] | tan δ [%] | HTLT | Thickness*3 [mm] | Soldering R:Reflow W:Wave |
|------------------|---------------|-------------------|-----------------------------|-----|-----------------|---------------------------|-----------|-------------------|------------------|---------------------------|
| | | | | | | | | Rated voltage x % | | |
| UMK316 LD105□L-T | | 50 | | X5R | 1 μ | ±10, ±20 | 10 | 150 | 1.6±0.20 | R |
| GMK316BLD475□L-T | | 35 | | X5R | 4.7 μ | ±10, ±20 | 10 | 150 | 1.6±0.30 | R |
| TMK316BLD106□L-T | | 25 | | X5R | 10 μ | ±10, ±20 | 10 | 150 | 1.6±0.30 | R |

● 325TYPE

【Temperature Characteristic LD : X5R】 1.9mm thickness(N)

| Part number 1 | Part number 2 | Rated voltage [V] | Temperature characteristics | | Capacitance [F] | Capacitance tolerance [%] | tan δ [%] | HTLT | Thickness*3 [mm] | Soldering R:Reflow W:Wave |
|------------------|---------------|-------------------|-----------------------------|-----|-----------------|---------------------------|-----------|-------------------|------------------|---------------------------|
| | | | | | | | | Rated voltage x % | | |
| UMK325 LD105□N-T | | 50 | | X5R | 1 μ | ±10, ±20 | 10 | 200 | 1.9±0.20 | R |

【Temperature Characteristic LD : X5R】 2.5mm thickness(M)

| Part number 1 | Part number 2 | Rated voltage [V] | Temperature characteristics | | Capacitance [F] | Capacitance tolerance [%] | tan δ [%] | HTLT | Thickness*3 [mm] | Soldering R:Reflow W:Wave |
|------------------|---------------|-------------------|-----------------------------|-----|-----------------|---------------------------|-----------|-------------------|------------------|---------------------------|
| | | | | | | | | Rated voltage x % | | |
| UMK325 LD155□M-T | | 50 | | X5R | 1.5 μ | ±10, ±20 | 5 | 150 | 2.5±0.20 | R |
| UMK325 LD475□M-T | | | | X5R | 4.7 μ | ±10, ±20 | 10 | 200 | 2.5±0.20 | R |

Medium-High Voltage Multilayer Ceramic Capacitors

● 105TYPE

【Temperature Characteristic B7 : X7R】 0.5mm thickness(V)

| Part number 1 | Part number 2 | Rated voltage [V] | Temperature characteristics | | Capacitance [F] | Capacitance tolerance [%] | tan δ [%] | HTLT | Thickness*3 [mm] | Soldering R:Reflow W:Wave |
|------------------|---------------|-------------------|-----------------------------|-----|-----------------|---------------------------|-----------|-------------------|------------------|---------------------------|
| | | | | | | | | Rated voltage x % | | |
| HMK105 B7221□V-F | | 100 | | X7R | 220 p | ±10, ±20 | 2.5 | 200 | 0.5±0.05 | R |
| HMK105 B7331□V-F | | | | X7R | 330 p | ±10, ±20 | 2.5 | 200 | 0.5±0.05 | R |
| HMK105 B7471□V-F | | | | X7R | 470 p | ±10, ±20 | 2.5 | 200 | 0.5±0.05 | R |
| HMK105 B7681□V-F | | | | X7R | 680 p | ±10, ±20 | 2.5 | 200 | 0.5±0.05 | R |
| HMK105 B7102□V-F | | | | X7R | 1000 p | ±10, ±20 | 2.5 | 200 | 0.5±0.05 | R |
| HMK105 B7152□V-F | | | | X7R | 1500 p | ±10, ±20 | 2.5 | 200 | 0.5±0.05 | R |
| HMK105 B7222□V-F | | | | X7R | 2200 p | ±10, ±20 | 2.5 | 200 | 0.5±0.05 | R |
| HMK105 B7332□V-F | | | | X7R | 3300 p | ±10, ±20 | 2.5 | 200 | 0.5±0.05 | R |
| HMK105 B7472□V-F | | | | X7R | 4700 p | ±10, ±20 | 2.5 | 200 | 0.5±0.05 | R |
| HMK105 B7682□V-F | | | | X7R | 7680 p | ±10, ±20 | 2.5 | 200 | 0.5±0.05 | R |

【Temperature Characteristic CG : CG/C0G】 0.5mm thickness(V)

| Part number 1 | Part number 2 | Rated voltage [V] | Temperature characteristics | | Capacitance [F] | Capacitance tolerance [%] | Q (at 1MHz) min | HTLT | Thickness*3 [mm] | Soldering R:Reflow W:Wave |
|------------------|---------------|-------------------|-----------------------------|-----|-----------------|---------------------------|-----------------|-------------------|------------------|---------------------------|
| | | | | | | | | Rated voltage x % | | |
| HMK105 CG080DV-F | | 100 | CG | C0G | 8 p | ±0.5pF | 560 | 200 | 0.5±0.05 | R |
| HMK105 CG090DV-F | | | CG | C0G | 9 p | ±0.5pF | 580 | 200 | 0.5±0.05 | R |
| HMK105 CG100DV-F | | | CG | C0G | 10 p | ±0.5pF | 600 | 200 | 0.5±0.05 | R |
| HMK105 CG120JV-F | | | CG | C0G | 12 p | ±5% | 640 | 200 | 0.5±0.05 | R |
| HMK105 CG150JV-F | | | CG | C0G | 15 p | ±5% | 700 | 200 | 0.5±0.05 | R |
| HMK105 CG180JV-F | | | CG | C0G | 18 p | ±5% | 760 | 200 | 0.5±0.05 | R |
| HMK105 CG220JV-F | | | CG | C0G | 22 p | ±5% | 840 | 200 | 0.5±0.05 | R |
| HMK105 CG240JV-F | | | CG | C0G | 24 p | ±5% | 880 | 200 | 0.5±0.05 | R |

● 107TYPE

【Temperature Characteristic BJ : B/X5R】 0.8mm thickness(A)

| Part number 1 | Part number 2 | Rated voltage [V] | Temperature characteristics | | Capacitance [F] | Capacitance tolerance [%] | tan δ [%] | HTLT | Thickness*3 [mm] | Soldering R:Reflow W:Wave |
|------------------|---------------|-------------------|-----------------------------|-------|-----------------|---------------------------|-----------|-------------------|------------------|---------------------------|
| | | | | | | | | Rated voltage x % | | |
| HMK107 BJ102□A-T | | 100 | B | X5R*1 | 1000 p | ±10, ±20 | 3.5 | 200 | 0.8±0.10 | R |
| HMK107 BJ152□A-T | | | B | X5R*1 | 1500 p | ±10, ±20 | 3.5 | 200 | 0.8±0.10 | R |
| HMK107 BJ222□A-T | | | B | X5R*1 | 2200 p | ±10, ±20 | 3.5 | 200 | 0.8±0.10 | R |
| HMK107 BJ332□A-T | | | B | X5R*1 | 3300 p | ±10, ±20 | 3.5 | 200 | 0.8±0.10 | R |
| HMK107 BJ472□A-T | | | B | X5R*1 | 4700 p | ±10, ±20 | 3.5 | 200 | 0.8±0.10 | R |
| HMK107 BJ682□A-T | | | B | X5R*1 | 6800 p | ±10, ±20 | 3.5 | 200 | 0.8±0.10 | R |
| HMK107 BJ103□A-T | | | B | X5R*1 | 10000 p | ±10, ±20 | 3.5 | 200 | 0.8±0.10 | R |
| HMK107 BJ153□A-T | | | B | X5R*1 | 15000 p | ±10, ±20 | 3.5 | 200 | 0.8±0.10 | R |
| HMK107 BJ223□A-T | | | B | X5R*1 | 22000 p | ±10, ±20 | 3.5 | 200 | 0.8±0.10 | R |
| HMK107 BJ333□A-T | | | B | X5R*1 | 33000 p | ±10, ±20 | 3.5 | 200 | 0.8±0.10 | R |
| HMK107 BJ473□A-T | | | B | X5R*1 | 47000 p | ±10, ±20 | 3.5 | 200 | 0.8±0.10 | R |
| HMK107 BJ104□A-T | | | B | X5R*1 | 0.1 μ | ±10, ±20 | 3.5 | 200 | 0.8±0.10 | R |

【Temperature Characteristic B7 : X7R】 0.8mm thickness(A)

| Part number 1 | Part number 2 | Rated voltage [V] | Temperature characteristics | | Capacitance [F] | Capacitance tolerance [%] | tan δ [%] | HTLT | Thickness*3 [mm] | Soldering R:Reflow W:Wave |
|------------------|---------------|-------------------|-----------------------------|-----|-----------------|---------------------------|-----------|-------------------|------------------|---------------------------|
| | | | | | | | | Rated voltage x % | | |
| HMK107 B7102□A-T | | 100 | | X7R | 1000 p | ±10, ±20 | 3.5 | 200 | 0.8±0.10 | R |
| HMK107 B7152□A-T | | | | X7R | 1500 p | ±10, ±20 | 3.5 | 200 | 0.8±0.10 | R |
| HMK107 B7222□A-T | | | | X7R | 2200 p | ±10, ±20 | 3.5 | 200 | 0.8±0.10 | R |
| HMK107 B7332□A-T | | | | X7R | 3300 p | ±10, ±20 | 3.5 | 200 | 0.8±0.10 | R |
| HMK107 B7472□A-T | | | | X7R | 4700 p | ±10, ±20 | 3.5 | 200 | 0.8±0.10 | R |
| HMK107 B7682□A-T | | | | X7R | 6800 p | ±10, ±20 | 3.5 | 200 | 0.8±0.10 | R |
| HMK107 B7103□A-T | | | | X7R | 10000 p | ±10, ±20 | 3.5 | 200 | 0.8±0.10 | R |
| HMK107 B7153□A-T | | | | X7R | 15000 p | ±10, ±20 | 3.5 | 200 | 0.8±0.10 | R |
| HMK107 B7223□A-T | | | | X7R | 22000 p | ±10, ±20 | 3.5 | 200 | 0.8±0.10 | R |
| HMK107 B7333□A-T | | | | X7R | 33000 p | ±10, ±20 | 3.5 | 200 | 0.8±0.10 | R |
| HMK107 B7473□A-T | | | | X7R | 47000 p | ±10, ±20 | 3.5 | 200 | 0.8±0.10 | R |
| HMK107 B7104□A-T | | | | X7R | 0.1 μ | ±10, ±20 | 3.5 | 200 | 0.8±0.10 | R |

【Temperature Characteristic SD : Standard】 0.8mm thickness(A)

| Part number 1 | Part number 2 | Rated voltage [V] | Temperature characteristics | | Capacitance [F] | Capacitance tolerance [%] | tan δ [%] | HTLT | Thickness*3 [mm] | Soldering R:Reflow W:Wave |
|------------------|---------------|-------------------|-----------------------------|--|-----------------|---------------------------|-----------|-------------------|------------------|---------------------------|
| | | | | | | | | Rated voltage x % | | |
| HMK107 SD101KA-T | | 100 | Standard Type | | 100 p | ±10 | 0.1 | 200 | 0.8±0.10 | R |
| HMK107 SD121KA-T | | | | | 120 p | ±10 | 0.1 | 200 | 0.8±0.10 | R |
| HMK107 SD151KA-T | | | | | 150 p | ±10 | 0.1 | 200 | 0.8±0.10 | R |
| HMK107 SD181KA-T | | | | | 180 p | ±10 | 0.1 | 200 | 0.8±0.10 | R |

▶ This catalog contains the typical specification only due to the limitation of space. When you consider the purchase of our products, please check our specification. For details of each product (characteristics graph, reliability information, precautions for use, and so on), see our Web site (<http://www.ty-top.com/>).

■ PARTS NUMBER

| Part number 1 | Part number 2 | Rated voltage [V] | Temperature characteristics | Capacitance [F] | Capacitance tolerance [%] | tan δ [%] | HTLT | Thickness* ³ [mm] | Soldering R:Reflow W:Wave |
|------------------|---------------|-------------------|-----------------------------|-----------------|---------------------------|-----------|-------------------|------------------------------|---------------------------|
| | | | | | | | Rated voltage x % | | |
| HMK107 SD221KA-T | | 100 | Standard Type | 220 p | ±10 | 0.1 | 200 | 0.8±0.10 | R |
| HMK107 SD271KA-T | | | | 270 p | ±10 | 0.1 | 200 | 0.8±0.10 | R |
| HMK107 SD331KA-T | | | | 330 p | ±10 | 0.1 | 200 | 0.8±0.10 | R |
| HMK107 SD391KA-T | | | | 390 p | ±10 | 0.1 | 200 | 0.8±0.10 | R |
| HMK107 SD471KA-T | | | | 470 p | ±10 | 0.1 | 200 | 0.8±0.10 | R |
| HMK107 SD561KA-T | | | | 560 p | ±10 | 0.1 | 200 | 0.8±0.10 | R |
| HMK107 SD681KA-T | | | | 680 p | ±10 | 0.1 | 200 | 0.8±0.10 | R |
| HMK107 SD821KA-T | | | | 820 p | ±10 | 0.1 | 200 | 0.8±0.10 | R |
| HMK107 SD102KA-T | | | | 1000 p | ±10 | 0.1 | 200 | 0.8±0.10 | R |

● 212TYPE

[Temperature Characteristic BJ : B/X5R] 1.25mm thickness(G)

| Part number 1 | Part number 2 | Rated voltage [V] | Temperature characteristics | | Capacitance [F] | Capacitance tolerance [%] | tan δ [%] | HTLT | Thickness* ³ [mm] | Soldering R:Reflow W:Wave |
|------------------|---------------|-------------------|-----------------------------|-------------------|-----------------|---------------------------|-----------|-------------------|------------------------------|---------------------------|
| | | | | | | | | Rated voltage x % | | |
| HMK212 BJ103□G-T | | 100 | B | X5R ⁺¹ | 10000 p | ±10, ±20 | 3.5 | 200 | 1.25±0.10 | R |
| HMK212 BJ153□G-T | | | | | 15000 p | ±10, ±20 | 3.5 | 200 | 1.25±0.10 | R |
| HMK212 BJ223□G-T | | | | | 22000 p | ±10, ±20 | 3.5 | 200 | 1.25±0.10 | R |
| HMK212 BJ333□G-T | | | | | 33000 p | ±10, ±20 | 3.5 | 200 | 1.25±0.10 | R |
| HMK212 BJ473□G-T | | | | | 47000 p | ±10, ±20 | 3.5 | 200 | 1.25±0.10 | R |
| HMK212 BJ683□G-T | | | | | 68000 p | ±10, ±20 | 3.5 | 200 | 1.25±0.10 | R |
| HMK212 BJ104□G-T | | | | | 0.1 μ | ±10, ±20 | 3.5 | 200 | 1.25±0.10 | R |
| HMK212 BJ224□G-T | | | | | 0.22 μ | ±10, ±20 | 3.5 | 200 | 1.25±0.10 | R |
| QMK212 BJ472□G-T | | | | | 4700 p | ±10, ±20 | 2.5 | 150 | 1.25±0.10 | R |
| QMK212 BJ682□G-T | | 6800 p | ±10, ±20 | 2.5 | 150 | 1.25±0.10 | R | | | |
| QMK212 BJ103□G-T | | 250 | B | X5R ⁺¹ | 10000 p | ±10, ±20 | 2.5 | 150 | 1.25±0.10 | R |
| QMK212 BJ153□G-T | | | | | 15000 p | ±10, ±20 | 2.5 | 150 | 1.25±0.10 | R |
| QMK212 BJ223□G-T | | | | | 22000 p | ±10, ±20 | 2.5 | 150 | 1.25±0.10 | R |
| QMK212 BJ332□G-T | | | | | 33000 p | ±10, ±20 | 2.5 | 150 | 1.25±0.10 | R |

[Temperature Characteristic BJ : B/X5R] 0.85mm thickness(D)

| Part number 1 | Part number 2 | Rated voltage [V] | Temperature characteristics | | Capacitance [F] | Capacitance tolerance [%] | tan δ [%] | HTLT | Thickness* ³ [mm] | Soldering R:Reflow W:Wave |
|------------------|---------------|-------------------|-----------------------------|-------------------|-----------------|---------------------------|-----------|-------------------|------------------------------|---------------------------|
| | | | | | | | | Rated voltage x % | | |
| QMK212 BJ102□D-T | | 250 | B | X5R ⁺¹ | 1000 p | ±10, ±20 | 2.5 | 150 | 0.85±0.10 | R |
| QMK212 BJ152□D-T | | | | | 1500 p | ±10, ±20 | 2.5 | 150 | 0.85±0.10 | R |
| QMK212 BJ222□D-T | | | | | 2200 p | ±10, ±20 | 2.5 | 150 | 0.85±0.10 | R |
| QMK212 BJ332□D-T | | | | | 3300 p | ±10, ±20 | 2.5 | 150 | 0.85±0.10 | R |

[Temperature Characteristic B7 : X7R] 1.25mm thickness(G)

| Part number 1 | Part number 2 | Rated voltage [V] | Temperature characteristics | | Capacitance [F] | Capacitance tolerance [%] | tan δ [%] | HTLT | Thickness* ³ [mm] | Soldering R:Reflow W:Wave |
|------------------|---------------|-------------------|-----------------------------|-----|-----------------|---------------------------|-----------|-------------------|------------------------------|---------------------------|
| | | | | | | | | Rated voltage x % | | |
| HMK212 B7103□G-T | | 100 | | X7R | 10000 p | ±10, ±20 | 3.5 | 200 | 1.25±0.10 | R |
| HMK212 B7153□G-T | | | | | 15000 p | ±10, ±20 | 3.5 | 200 | 1.25±0.10 | R |
| HMK212 B7223□G-T | | | | | 22000 p | ±10, ±20 | 3.5 | 200 | 1.25±0.10 | R |
| HMK212 B7333□G-T | | | | | 33000 p | ±10, ±20 | 3.5 | 200 | 1.25±0.10 | R |
| HMK212 B7473□G-T | | | | | 47000 p | ±10, ±20 | 3.5 | 200 | 1.25±0.10 | R |
| HMK212 B7683□G-T | | | | | 68000 p | ±10, ±20 | 3.5 | 200 | 1.25±0.10 | R |
| HMK212 B7104□G-T | | | | | 0.1 μ | ±10, ±20 | 3.5 | 200 | 1.25±0.10 | R |
| HMK212 B7224□G-T | | | | | 0.22 μ | ±10, ±20 | 3.5 | 200 | 1.25±0.10 | R |
| QMK212 B7472□G-T | | | | | 4700 p | ±10, ±20 | 2.5 | 150 | 1.25±0.10 | R |
| QMK212 B7682□G-T | | 6800 p | ±10, ±20 | 2.5 | 150 | 1.25±0.10 | R | | | |
| QMK212 B7103□G-T | | 250 | | X7R | 10000 p | ±10, ±20 | 2.5 | 150 | 1.25±0.10 | R |
| QMK212 B7153□G-T | | | | | 15000 p | ±10, ±20 | 2.5 | 150 | 1.25±0.10 | R |
| QMK212 B7223□G-T | | | | | 22000 p | ±10, ±20 | 2.5 | 150 | 1.25±0.10 | R |
| QMK212 B7332□G-T | | | | | 33000 p | ±10, ±20 | 2.5 | 150 | 1.25±0.10 | R |

[Temperature Characteristic B7 : X7R] 0.85mm thickness(D)

| Part number 1 | Part number 2 | Rated voltage [V] | Temperature characteristics | | Capacitance [F] | Capacitance tolerance [%] | tan δ [%] | HTLT | Thickness* ³ [mm] | Soldering R:Reflow W:Wave |
|------------------|---------------|-------------------|-----------------------------|-----|-----------------|---------------------------|-----------|-------------------|------------------------------|---------------------------|
| | | | | | | | | Rated voltage x % | | |
| QMK212 B7102□D-T | | 250 | | X7R | 1000 p | ±10, ±20 | 2.5 | 150 | 0.85±0.10 | R |
| QMK212 B7152□D-T | | | | | 1500 p | ±10, ±20 | 2.5 | 150 | 0.85±0.10 | R |
| QMK212 B7222□D-T | | | | | 2200 p | ±10, ±20 | 2.5 | 150 | 0.85±0.10 | R |
| QMK212 B7332□D-T | | | | | 3300 p | ±10, ±20 | 2.5 | 150 | 0.85±0.10 | R |

[Temperature Characteristic SD : Standard] 0.85mm thickness(D)

| Part number 1 | Part number 2 | Rated voltage [V] | Temperature characteristics | | Capacitance [F] | Capacitance tolerance [%] | tan δ [%] | HTLT | Thickness* ³ [mm] | Soldering R:Reflow W:Wave |
|------------------|---------------|-------------------|-----------------------------|---------------|-----------------|---------------------------|-----------|-------------------|------------------------------|---------------------------|
| | | | | | | | | Rated voltage x % | | |
| HMK212 SD222KD-T | | 100 | | Standard Type | 2200 p | ±10 | 0.1 | 200 | 0.85±0.10 | R |
| HMK212 SD472KD-T | | | | | 4700 p | ±10 | 0.1 | 200 | 0.85±0.10 | R |
| QMK212 SD101KD-T | | | | | 100 p | ±10 | 0.1 | 150 | 0.85±0.10 | R |
| QMK212 SD121KD-T | | | | | 120 p | ±10 | 0.1 | 150 | 0.85±0.10 | R |
| QMK212 SD151KD-T | | | | | 150 p | ±10 | 0.1 | 150 | 0.85±0.10 | R |
| QMK212 SD181KD-T | | | | | 180 p | ±10 | 0.1 | 150 | 0.85±0.10 | R |
| QMK212 SD221KD-T | | | | | 220 p | ±10 | 0.1 | 150 | 0.85±0.10 | R |
| QMK212 SD331KD-T | | | | | 330 p | ±10 | 0.1 | 150 | 0.85±0.10 | R |
| QMK212 SD391KD-T | | | | | 390 p | ±10 | 0.1 | 150 | 0.85±0.10 | R |
| QMK212 SD471KD-T | | 470 p | ±10 | 0.1 | 150 | 0.85±0.10 | R | | | |
| QMK212 SD561KD-T | | 560 p | ±10 | 0.1 | 150 | 0.85±0.10 | R | | | |
| QMK212 SD681KD-T | | 680 p | ±10 | 0.1 | 150 | 0.85±0.10 | R | | | |
| QMK212 SD821KD-T | | 820 p | ±10 | 0.1 | 150 | 0.85±0.10 | R | | | |
| QMK212 SD102KD-T | | 1000 p | ±10 | 0.1 | 150 | 0.85±0.10 | R | | | |

[Temperature Characteristic SD : Standard] 1.25mm thickness(G)

| Part number 1 | Part number 2 | Rated voltage [V] | Temperature characteristics | | Capacitance [F] | Capacitance tolerance [%] | tan δ [%] | HTLT | Thickness* ³ [mm] | Soldering R:Reflow W:Wave |
|------------------|---------------|-------------------|-----------------------------|---------------|-----------------|---------------------------|-----------|-------------------|------------------------------|---------------------------|
| | | | | | | | | Rated voltage x % | | |
| HMK212 SD392KG-T | | 100 | | Standard Type | 3900 p | ±10 | 0.1 | 200 | 1.25±0.10 | R |

▶ This catalog contains the typical specification only due to the limitation of space. When you consider the purchase of our products, please check our specification. For details of each product (characteristics graph, reliability information, precautions for use, and so on), see our Web site (<http://www.ty-top.com/>).

PARTS NUMBER

316TYPE

【Temperature Characteristic BJ : B/X5R】 1.6mm thickness(L)

| Part number 1 | Part number 2 | Rated voltage [V] | Temperature characteristics | | Capacitance [F] | Capacitance tolerance [%] | tan δ [%] | HTLT | Thickness* ³ [mm] | Soldering R:Reflow W:Wave |
|------------------|---------------|-------------------|-----------------------------|------------------|-----------------|---------------------------|-----------|-------------------|------------------------------|---------------------------|
| | | | | | | | | Rated voltage x % | | |
| HMK316 BJ473□L-T | | 100 | B | X5R ⁺ | 47000 p | ±10, ±20 | 3.5 | 200 | 1.6±0.20 | R |
| HMK316 BJ683□L-T | | | B | X5R ⁺ | 68000 p | ±10, ±20 | 3.5 | 200 | 1.6±0.20 | R |
| HMK316 BJ104□L-T | | | B | X5R ⁺ | 0.1 μ | ±10, ±20 | 3.5 | 200 | 1.6±0.20 | R |
| HMK316 BJ154□L-T | | | B | X5R ⁺ | 0.15 μ | ±10, ±20 | 3.5 | 200 | 1.6±0.20 | R |
| HMK316 BJ224□L-T | | | B | X5R ⁺ | 0.22 μ | ±10, ±20 | 3.5 | 200 | 1.6±0.20 | R |
| HMK316 BJ334□L-T | | | B | X5R ⁺ | 0.33 μ | ±10, ±20 | 3.5 | 200 | 1.6±0.20 | R |
| HMK316 BJ474□L-T | | | B | X5R ⁺ | 0.47 μ | ±10, ±20 | 3.5 | 200 | 1.6±0.20 | R |
| HMK316 BJ105□L-T | | | B | X5R ⁺ | 1 μ | ±10, ±20 | 3.5 | 200 | 1.6±0.20 | R |
| QMK316 BJ333□L-T | | 250 | B | X5R ⁺ | 33000 p | ±10, ±20 | 2.5 | 150 | 1.6±0.20 | R |
| QMK316 BJ473□L-T | | | B | X5R ⁺ | 47000 p | ±10, ±20 | 2.5 | 150 | 1.6±0.20 | R |
| QMK316 BJ683□L-T | | | B | X5R ⁺ | 68000 p | ±10, ±20 | 2.5 | 150 | 1.6±0.20 | R |
| QMK316 BJ104□L-T | | | B | X5R ⁺ | 0.1 μ | ±10, ±20 | 2.5 | 150 | 1.6±0.20 | R |
| SMK316 BJ153□L-T | | 630 | B | X5R ⁺ | 15000 p | ±10, ±20 | 2.5 | 120 | 1.6±0.20 | R |
| SMK316 BJ223□L-T | | | B | X5R ⁺ | 22000 p | ±10, ±20 | 2.5 | 120 | 1.6±0.20 | R |

【Temperature Characteristic BJ : B/X5R】 1.15mm thickness(F)

| Part number 1 | Part number 2 | Rated voltage [V] | Temperature characteristics | | Capacitance [F] | Capacitance tolerance [%] | tan δ [%] | HTLT | Thickness* ³ [mm] | Soldering R:Reflow W:Wave |
|------------------|---------------|-------------------|-----------------------------|------------------|-----------------|---------------------------|-----------|-------------------|------------------------------|---------------------------|
| | | | | | | | | Rated voltage x % | | |
| SMK316 BJ102□F-T | | 630 | B | X5R ⁺ | 1000 p | ±10, ±20 | 2.5 | 120 | 1.15±0.10 | R |
| SMK316 BJ152□F-T | | | B | X5R ⁺ | 1500 p | ±10, ±20 | 2.5 | 120 | 1.15±0.10 | R |
| SMK316 BJ222□F-T | | | B | X5R ⁺ | 2200 p | ±10, ±20 | 2.5 | 120 | 1.15±0.10 | R |
| SMK316 BJ332□F-T | | | B | X5R ⁺ | 3300 p | ±10, ±20 | 2.5 | 120 | 1.15±0.10 | R |
| SMK316 BJ472□F-T | | | B | X5R ⁺ | 4700 p | ±10, ±20 | 2.5 | 120 | 1.15±0.10 | R |
| SMK316 BJ682□F-T | | | B | X5R ⁺ | 6800 p | ±10, ±20 | 2.5 | 120 | 1.15±0.10 | R |
| SMK316 BJ103□F-T | | | B | X5R ⁺ | 10000 p | ±10, ±20 | 2.5 | 120 | 1.15±0.10 | R |

【Temperature Characteristic B7 : X7R】 1.6mm thickness(L)

| Part number 1 | Part number 2 | Rated voltage [V] | Temperature characteristics | | Capacitance [F] | Capacitance tolerance [%] | tan δ [%] | HTLT | Thickness* ³ [mm] | Soldering R:Reflow W:Wave |
|------------------|---------------|-------------------|-----------------------------|-----|-----------------|---------------------------|-----------|-------------------|------------------------------|---------------------------|
| | | | | | | | | Rated voltage x % | | |
| HMK316 B7473□L-T | | 100 | | X7R | 47000 p | ±10, ±20 | 3.5 | 200 | 1.6±0.20 | R |
| HMK316 B7683□L-T | | | | X7R | 68000 p | ±10, ±20 | 3.5 | 200 | 1.6±0.20 | R |
| HMK316 B7104□L-T | | | | X7R | 0.1 μ | ±10, ±20 | 3.5 | 200 | 1.6±0.20 | R |
| HMK316 B7154□L-T | | | | X7R | 0.15 μ | ±10, ±20 | 3.5 | 200 | 1.6±0.20 | R |
| HMK316 B7224□L-T | | | | X7R | 0.22 μ | ±10, ±20 | 3.5 | 200 | 1.6±0.20 | R |
| HMK316 B7334□L-T | | | | X7R | 0.33 μ | ±10, ±20 | 3.5 | 200 | 1.6±0.20 | R |
| HMK316 B7474□L-T | | | | X7R | 0.47 μ | ±10, ±20 | 3.5 | 200 | 1.6±0.20 | R |
| HMK316 B7105□L-T | | | | X7R | 1 μ | ±10, ±20 | 3.5 | 200 | 1.6±0.20 | R |
| QMK316 B7333□L-T | | 250 | | X7R | 33000 p | ±10, ±20 | 2.5 | 150 | 1.6±0.20 | R |
| QMK316 B7473□L-T | | | | X7R | 47000 p | ±10, ±20 | 2.5 | 150 | 1.6±0.20 | R |
| QMK316 B7683□L-T | | | | X7R | 68000 p | ±10, ±20 | 2.5 | 150 | 1.6±0.20 | R |
| QMK316 B7104□L-T | | | | X7R | 0.1 μ | ±10, ±20 | 2.5 | 150 | 1.6±0.20 | R |
| SMK316 B7153□L-T | | 630 | | X7R | 15000 p | ±10, ±20 | 2.5 | 120 | 1.6±0.20 | R |
| SMK316 B7223□L-T | | | | X7R | 22000 p | ±10, ±20 | 2.5 | 120 | 1.6±0.20 | R |

【Temperature Characteristic B7 : X7R】 1.15mm thickness(F)

| Part number 1 | Part number 2 | Rated voltage [V] | Temperature characteristics | | Capacitance [F] | Capacitance tolerance [%] | tan δ [%] | HTLT | Thickness* ³ [mm] | Soldering R:Reflow W:Wave |
|------------------|---------------|-------------------|-----------------------------|-----|-----------------|---------------------------|-----------|-------------------|------------------------------|---------------------------|
| | | | | | | | | Rated voltage x % | | |
| SMK316 B7102□F-T | | 630 | | X7R | 1000 p | ±10, ±20 | 2.5 | 120 | 1.15±0.10 | R |
| SMK316 B7152□F-T | | | | X7R | 1500 p | ±10, ±20 | 2.5 | 120 | 1.15±0.10 | R |
| SMK316 B7222□F-T | | | | X7R | 2200 p | ±10, ±20 | 2.5 | 120 | 1.15±0.10 | R |
| SMK316 B7332□F-T | | | | X7R | 3300 p | ±10, ±20 | 2.5 | 120 | 1.15±0.10 | R |
| SMK316 B7472□F-T | | | | X7R | 4700 p | ±10, ±20 | 2.5 | 120 | 1.15±0.10 | R |
| SMK316 B7682□F-T | | | | X7R | 6800 p | ±10, ±20 | 2.5 | 120 | 1.15±0.10 | R |
| SMK316 B7103□F-T | | | | X7R | 10000 p | ±10, ±20 | 2.5 | 120 | 1.15±0.10 | R |

【Temperature Characteristic SD : Standard】 1.6mm thickness(L)

| Part number 1 | Part number 2 | Rated voltage [V] | Temperature characteristics | | Capacitance [F] | Capacitance tolerance [%] | tan δ [%] | HTLT | Thickness* ³ [mm] | Soldering R:Reflow W:Wave |
|------------------|---------------|-------------------|-----------------------------|---------------|-----------------|---------------------------|-----------|-------------------|------------------------------|---------------------------|
| | | | | | | | | Rated voltage x % | | |
| HMK316 SD223KL-T | | 100 | | Standard Type | 22000 p | ±10 | 0.1 | 200 | 1.6±0.20 | R |
| QMK316 SD103KL-T | | 250 | | Standard Type | 10000 p | ±10 | 0.1 | 150 | 1.6±0.20 | R |

325TYPE

【Temperature Characteristic BJ : B/X5R】 2.5mm thickness(M)

| Part number 1 | Part number 2 | Rated voltage [V] | Temperature characteristics | | Capacitance [F] | Capacitance tolerance [%] | tan δ [%] | HTLT | Thickness* ³ [mm] | Soldering R:Reflow W:Wave |
|------------------|---------------|-------------------|-----------------------------|------------------|-----------------|---------------------------|-----------|-------------------|------------------------------|---------------------------|
| | | | | | | | | Rated voltage x % | | |
| HMK325 BJ225□M-T | | 100 | B | X5R ⁺ | 2.2 μ | ±10, ±20 | 3.5 | 200 | 2.5±0.20 | R |

【Temperature Characteristic BJ : B/X5R】 1.9mm thickness(N)

| Part number 1 | Part number 2 | Rated voltage [V] | Temperature characteristics | | Capacitance [F] | Capacitance tolerance [%] | tan δ [%] | HTLT | Thickness* ³ [mm] | Soldering R:Reflow W:Wave | |
|------------------|---------------|-------------------|-----------------------------|------------------|------------------|---------------------------|-----------|-------------------|------------------------------|---------------------------|---|
| | | | | | | | | Rated voltage x % | | | |
| HMK325 BJ154□N-T | | 100 | B | X5R ⁺ | 0.15 μ | ±10, ±20 | 3.5 | 200 | 1.9±0.20 | R | |
| HMK325 BJ224□N-T | | | B | X5R ⁺ | 0.22 μ | ±10, ±20 | 3.5 | 200 | 1.9±0.20 | R | |
| HMK325 BJ334□N-T | | | B | X5R ⁺ | 0.33 μ | ±10, ±20 | 3.5 | 200 | 1.9±0.20 | R | |
| HMK325 BJ474□N-T | | | B | X5R ⁺ | 0.47 μ | ±10, ±20 | 3.5 | 200 | 1.9±0.20 | R | |
| HMK325 BJ684□N-T | | | B | X5R ⁺ | 0.68 μ | ±10, ±20 | 3.5 | 200 | 1.9±0.20 | R | |
| HMK325 BJ105□N-T | | | B | X5R ⁺ | 1 μ | ±10, ±20 | 3.5 | 200 | 1.9±0.20 | R | |
| QMK325 BJ473□N-T | | | 250 | B | X5R ⁺ | 47000 p | ±10, ±20 | 2.5 | 150 | 1.9±0.20 | R |
| QMK325 BJ104□N-T | | | | B | X5R ⁺ | 0.1 μ | ±10, ±20 | 2.5 | 150 | 1.9±0.20 | R |
| QMK325 BJ154□N-T | | B | | X5R ⁺ | 0.15 μ | ±10, ±20 | 2.5 | 150 | 1.9±0.20 | R | |
| QMK325 BJ224□N-T | | B | | X5R ⁺ | 0.22 μ | ±10, ±20 | 2.5 | 150 | 1.9±0.20 | R | |
| SMK325 BJ223□N-T | | 630 | B | X5R ⁺ | 22000 p | ±10, ±20 | 2.5 | 120 | 1.9±0.20 | R | |
| SMK325 BJ333□N-T | | | B | X5R ⁺ | 33000 p | ±10, ±20 | 2.5 | 120 | 1.9±0.20 | R | |
| SMK325 BJ473□N-T | | | B | X5R ⁺ | 47000 p | ±10, ±20 | 2.5 | 120 | 1.9±0.20 | R | |

▶ This catalog contains the typical specification only due to the limitation of space. When you consider the purchase of our products, please check our specification. For details of each product (characteristics graph, reliability information, precautions for use, and so on), see our Web site (<http://www.ty-top.com/>).

■ PARTS NUMBER

[Temperature Characteristic BJ : B/X5R] 1.15mm thickness(F)

| Part number 1 | Part number 2 | Rated voltage [V] | Temperature characteristics | Capacitance [F] | Capacitance tolerance [%] | tan δ [%] | HTLT | | Thickness*3 [mm] | Soldering R:Reflow W:Wave |
|------------------|---------------|-------------------|-----------------------------|-----------------|---------------------------|-----------|-------------------|--|------------------|---------------------------|
| | | | | | | | Rated voltage x % | | | |
| HMK325 BJ104[F-T | | 100 | B X5R ¹ | 0.1 μ | ±10, ±20 | 3.5 | 200 | | 1.15±0.10 | R |

[Temperature Characteristic B7 : X7R] 2.5mm thickness(M)

| Part number 1 | Part number 2 | Rated voltage [V] | Temperature characteristics | Capacitance [F] | Capacitance tolerance [%] | tan δ [%] | HTLT | | Thickness*3 [mm] | Soldering R:Reflow W:Wave |
|------------------|---------------|-------------------|-----------------------------|-----------------|---------------------------|-----------|-------------------|--|------------------|---------------------------|
| | | | | | | | Rated voltage x % | | | |
| HMK325 B7225[M-T | | 100 | X7R | 2.2 μ | ±10, ±20 | 3.5 | 200 | | 2.5±0.20 | R |

[Temperature Characteristic B7 : X7R] 1.9mm thickness(N)

| Part number 1 | Part number 2 | Rated voltage [V] | Temperature characteristics | Capacitance [F] | Capacitance tolerance [%] | tan δ [%] | HTLT | | Thickness*3 [mm] | Soldering R:Reflow W:Wave |
|------------------|---------------|-------------------|-----------------------------|-----------------|---------------------------|-----------|-------------------|----------|------------------|---------------------------|
| | | | | | | | Rated voltage x % | | | |
| HMK325 B7154[N-T | | 100 | X7R | 0.15 μ | ±10, ±20 | 3.5 | 200 | | 1.9±0.20 | R |
| HMK325 B7224[N-T | | | X7R | 0.22 μ | ±10, ±20 | 3.5 | 200 | | 1.9±0.20 | R |
| HMK325 B7334[N-T | | | X7R | 0.33 μ | ±10, ±20 | 3.5 | 200 | | 1.9±0.20 | R |
| HMK325 B7474[N-T | | | X7R | 0.47 μ | ±10, ±20 | 3.5 | 200 | | 1.9±0.20 | R |
| HMK325 B7684[N-T | | | X7R | 0.68 μ | ±10, ±20 | 3.5 | 200 | | 1.9±0.20 | R |
| HMK325 B7105[N-T | | | X7R | 1 μ | ±10, ±20 | 3.5 | 200 | | 1.9±0.20 | R |
| QMK325 B7473[N-T | | 250 | X7R | 47000 p | ±10, ±20 | 2.5 | 150 | | 1.9±0.20 | R |
| QMK325 B7104[N-T | | | X7R | 0.1 μ | ±10, ±20 | 2.5 | 150 | | 1.9±0.20 | R |
| QMK325 B7154[N-T | | | X7R | 0.15 μ | ±10, ±20 | 2.5 | 150 | | 1.9±0.20 | R |
| QMK325 B7224[N-T | | 630 | X7R | 0.22 μ | ±10, ±20 | 2.5 | 150 | | 1.9±0.20 | R |
| SMK325 B7223[N-T | | | X7R | 22000 p | ±10, ±20 | 2.5 | 120 | | 1.9±0.20 | R |
| SMK325 B7333[N-T | | | X7R | 33000 p | ±10, ±20 | 2.5 | 120 | | 1.9±0.20 | R |
| SMK325 B7473[N-T | | X7R | 47000 p | ±10, ±20 | 2.5 | 120 | | 1.9±0.20 | R | |

[Temperature Characteristic B7 : X7R] 1.15mm thickness(F)

| Part number 1 | Part number 2 | Rated voltage [V] | Temperature characteristics | Capacitance [F] | Capacitance tolerance [%] | tan δ [%] | HTLT | | Thickness*3 [mm] | Soldering R:Reflow W:Wave |
|------------------|---------------|-------------------|-----------------------------|-----------------|---------------------------|-----------|-------------------|--|------------------|---------------------------|
| | | | | | | | Rated voltage x % | | | |
| HMK325 B7104[F-T | | 100 | X7R | 0.1 μ | ±10, ±20 | 3.5 | 200 | | 1.15±0.10 | R |

● 432TYPE

[Temperature Characteristic BJ : B/X5R] 2.5mm thickness(M)

| Part number 1 | Part number 2 | Rated voltage [V] | Temperature characteristics | Capacitance [F] | Capacitance tolerance [%] | tan δ [%] | HTLT | | Thickness*3 [mm] | Soldering R:Reflow W:Wave |
|------------------|---------------|-------------------|-----------------------------|-----------------|---------------------------|-----------|-------------------|--|------------------|---------------------------|
| | | | | | | | Rated voltage x % | | | |
| HMK432 BJ474[M-T | | 100 | B X5R ¹ | 0.47 μ | ±10, ±20 | 3.5 | 200 | | 2.5±0.20 | R |
| HMK432 BJ105[M-T | | | B X5R ¹ | 1 μ | ±10, ±20 | 3.5 | 200 | | 2.5±0.20 | R |
| HMK432 BJ155[M-T | | | B X5R ¹ | 1.5 μ | ±10, ±20 | 3.5 | 200 | | 2.5±0.20 | R |
| HMK432 BJ225[M-T | | | B X5R ¹ | 2.2 μ | ±10, ±20 | 3.5 | 200 | | 2.5±0.20 | R |
| QMK432 BJ104[M-T | | | B X5R ¹ | 0.1 μ | ±10, ±20 | 2.5 | 150 | | 2.5±0.20 | R |
| QMK432 BJ224[M-T | | | B X5R ¹ | 0.22 μ | ±10, ±20 | 2.5 | 150 | | 2.5±0.20 | R |
| QMK432 BJ334[M-T | | 250 | B X5R ¹ | 0.33 μ | ±10, ±20 | 2.5 | 150 | | 2.5±0.20 | R |
| QMK432 BJ474[M-T | | | B X5R ¹ | 0.47 μ | ±10, ±20 | 2.5 | 150 | | 2.5±0.20 | R |
| SMK432 BJ473[M-T | | | B X5R ¹ | 47000 p | ±10, ±20 | 2.5 | 120 | | 2.5±0.20 | R |
| SMK432 BJ683[M-T | | 630 | B X5R ¹ | 68000 p | ±10, ±20 | 2.5 | 120 | | 2.5±0.20 | R |
| SMK432 BJ104[M-T | | | B X5R ¹ | 0.1 μ | ±10, ±20 | 2.5 | 120 | | 2.5±0.20 | R |

[Temperature Characteristic B7 : X7R] 2.5mm thickness(M)

| Part number 1 | Part number 2 | Rated voltage [V] | Temperature characteristics | Capacitance [F] | Capacitance tolerance [%] | tan δ [%] | HTLT | | Thickness*3 [mm] | Soldering R:Reflow W:Wave |
|------------------|---------------|-------------------|-----------------------------|-----------------|---------------------------|-----------|-------------------|--|------------------|---------------------------|
| | | | | | | | Rated voltage x % | | | |
| HMK432 B7474[M-T | | 100 | X7R | 0.47 μ | ±10, ±20 | 3.5 | 200 | | 2.5±0.20 | R |
| HMK432 B7105[M-T | | | X7R | 1 μ | ±10, ±20 | 3.5 | 200 | | 2.5±0.20 | R |
| HMK432 B7155[M-T | | | X7R | 1.5 μ | ±10, ±20 | 3.5 | 200 | | 2.5±0.20 | R |
| HMK432 B7225[M-T | | | X7R | 2.2 μ | ±10, ±20 | 3.5 | 200 | | 2.5±0.20 | R |
| QMK432 B7104[M-T | | | X7R | 0.1 μ | ±10, ±20 | 2.5 | 150 | | 2.5±0.20 | R |
| QMK432 B7224[M-T | | | X7R | 0.22 μ | ±10, ±20 | 2.5 | 150 | | 2.5±0.20 | R |
| QMK432 B7334[M-T | | 250 | X7R | 0.33 μ | ±10, ±20 | 2.5 | 150 | | 2.5±0.20 | R |
| QMK432 B7474[M-T | | | X7R | 0.47 μ | ±10, ±20 | 2.5 | 150 | | 2.5±0.20 | R |
| SMK432 B7473[M-T | | | X7R | 47000 p | ±10, ±20 | 2.5 | 120 | | 2.5±0.20 | R |
| SMK432 B7683[M-T | | 630 | X7R | 68000 p | ±10, ±20 | 2.5 | 120 | | 2.5±0.20 | R |
| SMK432 B7104[M-T | | | X7R | 0.1 μ | ±10, ±20 | 2.5 | 120 | | 2.5±0.20 | R |

LW Reversal Decoupling Capacitors (LWDC™)

● 105TYPE

[Temperature Characteristic BJ : X5R] 0.3mm thickness(P)

| Part number 1 | Part number 2 | Rated voltage [V] | Temperature characteristics | Capacitance [F] | Capacitance tolerance [%] | tan δ [%] | HTLT | | Thickness*3 [mm] | Soldering R:Reflow W:Wave | |
|------------------|---------------|-------------------|-----------------------------|-----------------|---------------------------|-----------|-------------------|-----|------------------|---------------------------|---|
| | | | | | | | Rated voltage x % | | | | |
| TWK105 BJ104MP-F | | 25 | X5R | 0.1 μ | ±20 | 5 | 150 | | 0.3±0.05 | R | |
| EWK105 BJ224MP-F | | 16 | X5R | 0.22 μ | ±20 | 10 | 150 | | 0.3±0.05 | R | |
| LWK105 BJ474MP-F | | 10 | X5R | 0.47 μ | ±20 | 10 | 150 | | 0.3±0.05 | R | |
| JWK105 BJ104MP-F | | 6.3 | X5R ¹ | 0.1 μ | ±20 | 5 | 150 | | 0.3±0.05 | R | |
| JWK105 BJ474MP-F | | | X5R ¹ | 0.47 μ | ±20 | 10 | 150 | | 0.3±0.05 | R | |
| JWK105 BJ105MP-F | | | X5R | 1 μ | ±20 | 10 | 150 | | 0.3±0.05 | R | |
| JWK105 BJ225MP-F | | | X5R | 2.2 μ | ±20 | 10 | 150 | | 0.3±0.05 | R | |
| AWK105 BJ224MP-F | | | 4 | X5R | 0.22 μ | ±20 | 10 | 150 | | 0.3±0.05 | R |

[Temperature Characteristic C6 : X6S, C7 : X7S] 0.3mm thickness(P)

| Part number 1 | Part number 2 | Rated voltage [V] | Temperature characteristics | Capacitance [F] | Capacitance tolerance [%] | tan δ [%] | HTLT | | Thickness*3 [mm] | Soldering R:Reflow W:Wave |
|------------------|---------------|-------------------|-----------------------------|-----------------|---------------------------|-----------|-------------------|--|------------------|---------------------------|
| | | | | | | | Rated voltage x % | | | |
| EWK105 C6104MP-F | | 16 | X6S | 0.1 μ | ±20 | 5 | 150 | | 0.3±0.05 | R |
| LWK105 C7104MP-F | | 10 | X7S | 0.1 μ | ±20 | 5 | 150 | | 0.3±0.05 | R |
| LWK105 C6224MP-F | | | X6S | 0.22 μ | ±20 | 10 | 150 | | 0.3±0.05 | R |
| JWK105 C7104MP-F | | 6.3 | X7S | 0.1 μ | ±20 | 5 | 150 | | 0.3±0.05 | R |
| JWK105 C7224MP-F | | | X7S | 0.22 μ | ±20 | 10 | 150 | | 0.3±0.05 | R |
| JWK105 C6474MP-F | | | X6S | 0.47 μ | ±20 | 10 | 150 | | 0.3±0.05 | R |

▶ This catalog contains the typical specification only due to the limitation of space. When you consider the purchase of our products, please check our specification. For details of each product (characteristics graph, reliability information, precautions for use, and so on), see our Web site (<http://www.ty-top.com/>).

■ PARTS NUMBER

| Part number 1 | Part number 2 | Rated voltage [V] | Temperature characteristics | Capacitance [F] | Capacitance tolerance [%] | tan δ [%] | HTLT | Thickness*3 [mm] | Soldering R:Reflow W:Wave |
|------------------|---------------|-------------------|-----------------------------|-----------------|---------------------------|-----------|-------------------|------------------|---------------------------|
| | | | | | | | Rated voltage x % | | |
| AWK105 C6224MP-F | | 4 | X6S | 0.22 μ | ±20 | 10 | 150 | 0.3±0.05 | R |
| AWK105 C6474MP-F | | | X6S | 0.47 μ | ±20 | 10 | 150 | 0.3±0.05 | R |
| AWK105 C6105MP-F | | | X6S | 1 μ | ±20 | 10 | 150 | 0.3±0.05 | R |
| AWK105 C6225MP-F | | | X6S | 2.2 μ | ±20 | 10 | 150 | 0.3±0.05 | R |

● 107TYPE

【Temperature Characteristic BJ : X5R】 0.5mm thickness (V)

| Part number 1 | Part number 2 | Rated voltage [V] | Temperature characteristics | Capacitance [F] | Capacitance tolerance [%] | tan δ [%] | HTLT | Thickness*3 [mm] | Soldering R:Reflow W:Wave |
|------------------|---------------|-------------------|-----------------------------|-----------------|---------------------------|-----------|-------------------|------------------|---------------------------|
| | | | | | | | Rated voltage x % | | |
| TWK107 BJ104MV-T | | 25 | X5R ⁺¹ | 0.1 μ | ±20 | 5 | 150 | 0.5±0.05 | R |
| EWK107 BJ224MV-T | | 16 | X5R ⁺¹ | 0.22 μ | ±20 | 5 | 150 | 0.5±0.05 | R |
| EWK107 BJ474MV-T | | | X5R ⁺¹ | 0.47 μ | ±20 | 5 | 150 | 0.5±0.05 | R |
| LWK107 BJ105MV-T | | 10 | X5R | 1 μ | ±20 | 10 | 150 | 0.5±0.05 | R |
| LWK107 BJ225MV-T | | | X5R | 2.2 μ | ±20 | 10 | 150 | 0.5±0.05 | R |
| JWK107 BJ105MV-T | | 6.3 | X5R ⁺¹ | 1 μ | ±20 | 10 | 150 | 0.5±0.05 | R |
| JWK107 BJ225MV-T | | | X5R | 2.2 μ | ±20 | 10 | 150 | 0.5±0.05 | R |
| JWK107 BJ475MV-T | | | X5R | 4.7 μ | ±20 | 10 | 150 | 0.5±0.05 | R |
| AWK107 BJ106MV-T | | 4 | X5R | 10 μ | ±20 | 10 | 150 | 0.5±0.05 | R |

【Temperature Characteristic B7 : X7R, C6 : X6S, C7 : X7S】 0.5mm thickness (V)

| Part number 1 | Part number 2 | Rated voltage [V] | Temperature characteristics | Capacitance [F] | Capacitance tolerance [%] | tan δ [%] | HTLT | Thickness*3 [mm] | Soldering R:Reflow W:Wave |
|------------------|---------------|-------------------|-----------------------------|-----------------|---------------------------|-----------|-------------------|------------------|---------------------------|
| | | | | | | | Rated voltage x % | | |
| TWK107 B7104MV-T | | 25 | X7R | 0.1 μ | ±20 | 5 | 150 | 0.5±0.05 | R |
| EWK107 B7224MV-T | | 16 | X7R | 0.22 μ | ±20 | 5 | 150 | 0.5±0.05 | R |
| EWK107 B7474MV-T | | | X7R | 0.47 μ | ±20 | 5 | 150 | 0.5±0.05 | R |
| JWK107 C7105MV-T | | 6.3 | X7S | 1 μ | ±20 | 10 | 150 | 0.5±0.05 | R |
| AWK107 C7225MV-T | | 4 | X7S | 2.2 μ | ±20 | 10 | 150 | 0.5±0.05 | R |
| AWK107 C6475MV-T | | | X6S | 4.7 μ | ±20 | 10 | 150 | 0.5±0.05 | R |
| PWK107 C6106MV-T | | 2.5 | X6S | 10 μ | ±20 | 10 | 150 | 0.5±0.05 | R |

● 212TYPE

【Temperature Characteristic BJ : X5R】 0.85mm thickness (D)

| Part number 1 | Part number 2 | Rated voltage [V] | Temperature characteristics | Capacitance [F] | Capacitance tolerance [%] | tan δ [%] | HTLT | Thickness*3 [mm] | Soldering R:Reflow W:Wave |
|------------------|---------------|-------------------|-----------------------------|-----------------|---------------------------|-----------|-------------------|------------------|---------------------------|
| | | | | | | | Rated voltage x % | | |
| TWK212 BJ475□D-T | | 25 | X5R | 4.7 μ | ±10, ±20 | 10 | 150 | 0.85±0.10 | R |
| EWK212 BJ106MD-T | | 16 | X5R | 10 μ | ±20 | 10 | 150 | 0.85±0.10 | R |
| LWK212 BJ475□D-T | | 10 | X5R | 4.7 μ | ±10, ±20 | 10 | 150 | 0.85±0.10 | R |
| LWK212 BJ106MD-T | | | X5R | 10 μ | ±20 | 10 | 150 | 0.85±0.10 | R |
| JWK212 BJ226MD-T | | 6.3 | X5R | 22 μ | ±20 | 10 | 150 | 0.85±0.10 | R |

【Temperature Characteristic B7 : X7R, C6 : X6S】 0.85mm thickness (D)

| Part number 1 | Part number 2 | Rated voltage [V] | Temperature characteristics | Capacitance [F] | Capacitance tolerance [%] | tan δ [%] | HTLT | Thickness*3 [mm] | Soldering R:Reflow W:Wave |
|------------------|---------------|-------------------|-----------------------------|-----------------|---------------------------|-----------|-------------------|------------------|---------------------------|
| | | | | | | | Rated voltage x % | | |
| TWK212 B7225□D-T | | 25 | X7R | 2.2 μ | ±10, ±20 | 5 | 150 | 0.85±0.10 | R |
| EWK212 C6475□D-T | | 16 | X6S | 4.7 μ | ±10, ±20 | 10 | 150 | 0.85±0.10 | R |
| LWK212 C6106MD-T | | 10 | X6S | 10 μ | ±20 | 10 | 150 | 0.85±0.10 | R |
| AWK212 C6226MD-T | | 4 | X6S | 22 μ | ±20 | 10 | 150 | 0.85±0.10 | R |

▶ This catalog contains the typical specification only due to the limitation of space. When you consider the purchase of our products, please check our specification. For details of each product (characteristics graph, reliability information, precautions for use, and so on), see our Web site (<http://www.ty-top.com/>).

Multilayer Ceramic Capacitors

PACKAGING

① Minimum Quantity

● Taped package

| Type(EIA) | Thickness | | Standard quantity [pcs] | | |
|----------------|-----------|------|-------------------------|-----------------|------|
| | mm | code | Paper tape | Embossed tape | |
| □MK042(01005) | 0.2 | C, D | — | 40000 | |
| □VS042(01005) | 0.2 | C | | | |
| □MK063(0201) | 0.3 | P, T | 15000 | — | |
| □WK105(0204) ※ | 0.3 | P | 10000 | | |
| □MK105(0402) | 0.2 | C | 20000 | | |
| | 0.3 | P | 15000 | | |
| | 0.5 | V | 10000 | | |
| □VK105(0402) ※ | 0.5 | W | | | |
| □MK107(0603) | 0.45 | K | 4000 | | 4000 |
| □WK107(0306) ※ | 0.5 | V | — | | |
| □MR107(0603) | 0.8 | A | 4000 | | |
| □MK212(0805) | 0.45 | K | | | |
| □WK212(0508) ※ | 0.85 | D | — | — | |
| □MR212(0805) | 125 | G | — | | 3000 |
| □MK316(1206) | 0.85 | D | 4000 | — | |
| | 1.15 | F | — | 3000 | |
| | 125 | G | — | 2000 | |
| □MK325(1210) | 0.85 | D | — | 2000 | |
| | 1.15 | F | | | |
| | 1.9 | N | | | |
| | 2.0max. | Y | | | |
| | 2.5 | M | | | |
| □MR325(1210) | 2.5 | M | — | 500(T), 1000(P) | |
| □MK432(1812) | 2.5 | M | — | 500 | |

Note : ※ LW Reverse type.

② Taping material

※No bottom tape for pressed carrier tape

● Card board carrier tape

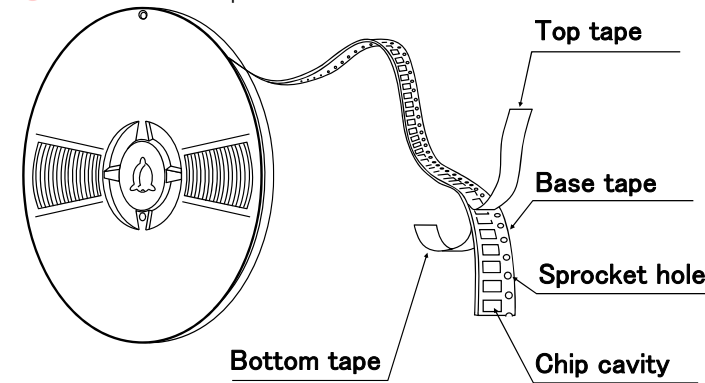

● Embossed tape

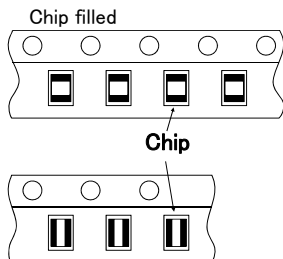
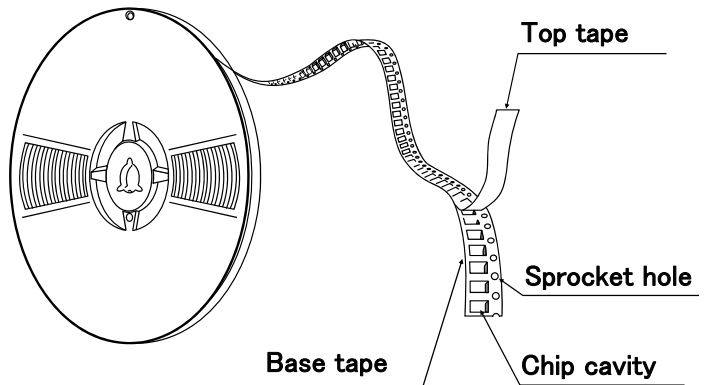

▶ This catalog contains the typical specification only due to the limitation of space. When you consider the purchase of our products, please check our specification. For details of each product (characteristics graph, reliability information, precautions for use, and so on), see our Web site (<http://www.ty-top.com/>).

③ Representative taping dimensions

● Paper Tape (8mm wide)

● Pressed carrier tape (2mm pitch)

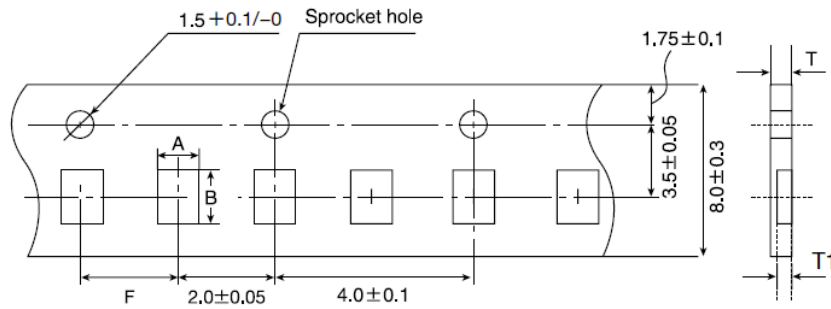

Unit : mm

| Type(EIA) | Chip Cavity | | Insertion Pitch F | Tape Thickness | |
|---------------------|-------------|------|----------------------|----------------|----------|
| | A | B | | T | T1 |
| □MK063(0201) | 0.37 | 0.67 | 2.0±0.05 | 0.45max. | 0.42max. |
| □WK105(0204) ※ | 0.65 | 1.15 | | 0.4max. | 0.3max. |
| □MK105(0402) (*1 C) | | | | 0.45max. | 0.42max. |
| □MK105(0402) (*1 P) | | | | | |

Note *1 Thickness, C:0.2mm ,P:0.3mm. ※ LW Reverse type.

Unit : mm

● Punched carrier tape (2mm pitch)

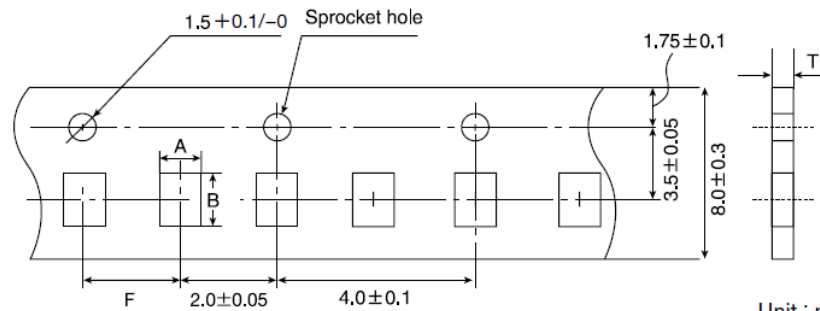

Unit : mm

| Type(EIA) | Chip Cavity | | Insertion Pitch F | Tape Thickness |
|---------------|-------------|------|----------------------|----------------|
| | A | B | | T |
| □MK105 (0402) | 0.65 | 1.15 | 2.0±0.05 | 0.8max. |
| □VK105 (0402) | | | | |

Unit : mm

● Punched carrier tape (4mm pitch)

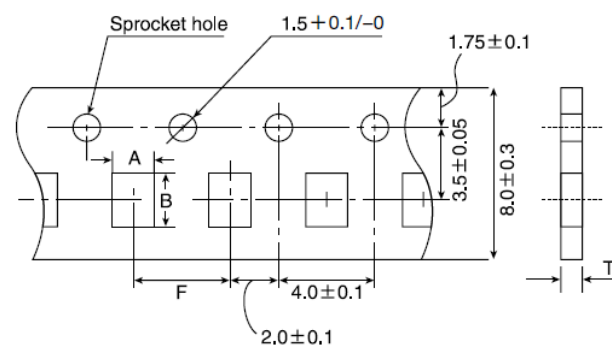

Unit : mm

| Type(EIA) | Chip Cavity | | Insertion Pitch F | Tape Thickness |
|----------------|-------------|-----|----------------------|----------------|
| | A | B | | T |
| □MK107(0603) | 1.0 | 1.8 | 4.0±0.1 | 1.1max. |
| □WK107(0306) ※ | | | | 1.1max. |
| □MR107(0603) | | | | |
| □MK212(0805) | 1.65 | 2.4 | | 1.1max. |
| □WK212(0508) ※ | | | | 1.1max. |
| □MK316(1206) | | | | |

Note : Taping size might be different depending on the size of the product. ※ LW Reverse type.

Unit : mm

● Embossed tape (4mm wide)

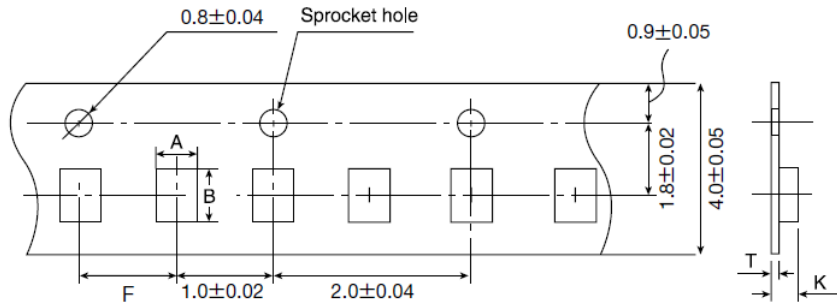

Unit : mm

| Type(EIA) | Chip Cavity | | Insertion Pitch F | Tape Thickness | |
|---------------|-------------|------|----------------------|----------------|----------|
| | A | B | | K | T |
| □MK042(01005) | 0.23 | 0.43 | 1.0±0.02 | 0.5max. | 0.25max. |
| □VS042(01005) | | | | | |

Unit : mm

● Embossed tape (8mm wide)

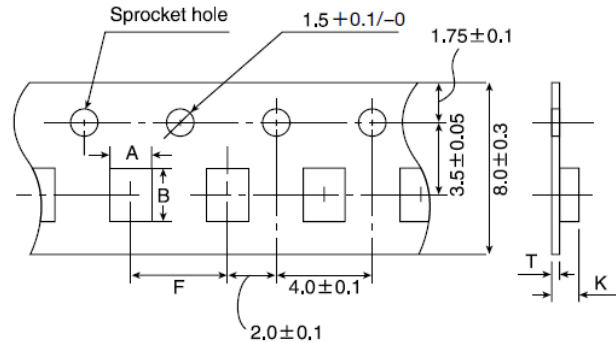

Unit : mm

| Type(EIA) | Chip Cavity | | Insertion Pitch F | Tape Thickness | |
|----------------|-------------|-----|----------------------|----------------|----------|
| | A | B | | K | T |
| □WK107(0306) ※ | 1.0 | 1.8 | 4.0±0.1 | 1.3max. | 0.25±0.1 |
| □MK212(0805) | 1.65 | 2.4 | | 3.4max. | 0.6max. |
| □MR212(0805) | | | | | |
| □MK316(1206) | 2.0 | 3.6 | | | |
| □MR316(1206) | | | | | |
| □MK325(1210) | 2.8 | 3.6 | | | |
| □MR325(1210) | | | | | |

Note: ※ LW Reverse type.

Unit : mm

● Embossed tape (12mm wide)

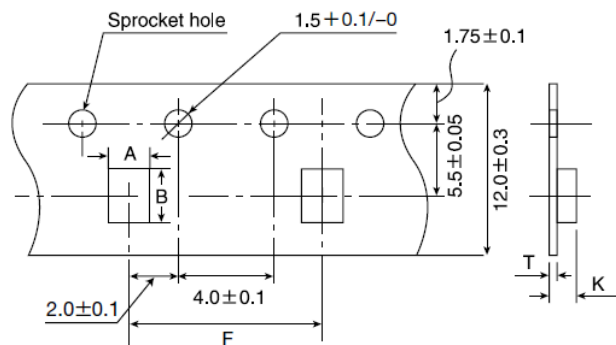

Unit : mm

| Type(EIA) | Chip Cavity | | Insertion Pitch F | Tape Thickness | |
|--------------|-------------|-----|----------------------|----------------|---------|
| | A | B | | K | T |
| □MK432(1812) | 3.7 | 4.9 | 8.0±0.1 | 4.0max. | 0.6max. |

Unit : mm

▶ This catalog contains the typical specification only due to the limitation of space. When you consider the purchase of our products, please check our specification. For details of each product (characteristics graph, reliability information, precautions for use, and so on), see our Web site (<http://www.ty-top.com/>).

④Trailer and Leader

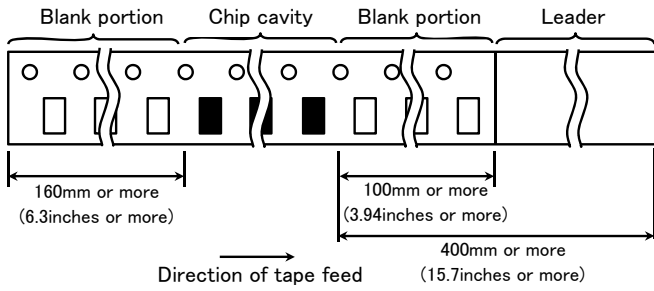

⑤Reel size

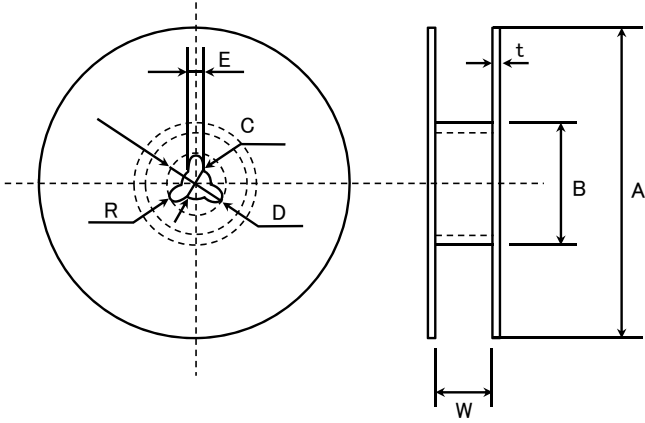

| A | B | C | D | E | R |
|--------------------|-----------------------|---------------------|---------------------|---------------|-----|
| $\phi 178 \pm 2.0$ | $\phi 50 \text{min.}$ | $\phi 13.0 \pm 0.2$ | $\phi 21.0 \pm 0.8$ | 2.0 ± 0.5 | 1.0 |
| | T | W | | | |
| 4mm wide tape | 1.5max. | 5 ± 1.0 | | | |
| 8mm wide tape | 2.5max. | 10 ± 1.5 | | | |
| 12mm wide tape | 2.5max. | 14 ± 1.5 | | | |

Unit: mm

⑥Top Tape Strength

The top tape requires a peel-off force of 0.1 to 0.7N in the direction of the arrow as illustrated below.

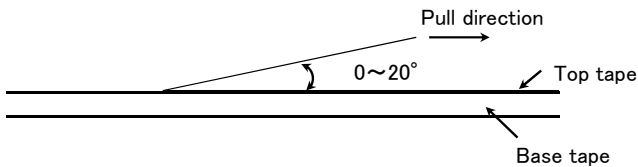

⑦Bulk Cassette

The exchange of individual specification is necessary.
Please contact Taiyo Yuden sales channels.

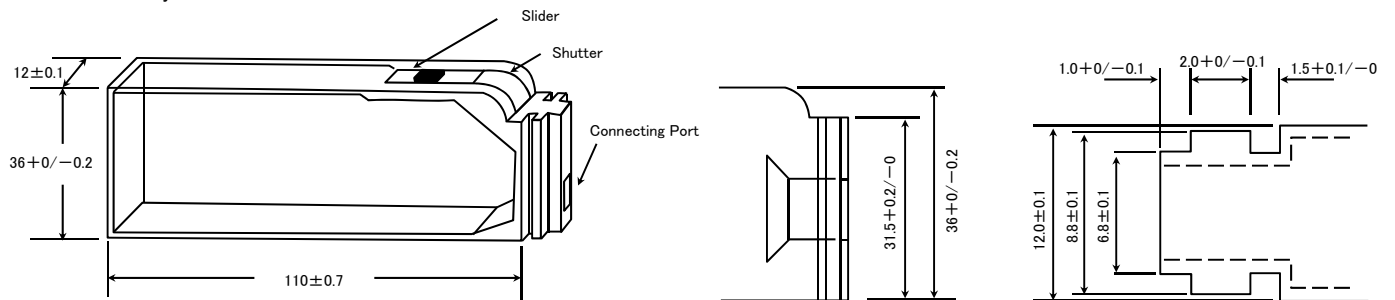

Unit: mm

Multilayer Ceramic Capacitors

RELIABILITY DATA

1. Operating Temperature Range

| | | | | |
|-----------------|-----------------------------------|---------------------|---------------|-------------------|
| Specified Value | Temperature Compensating (Class1) | Standard | -55 to +125°C | |
| | | High Frequency Type | | |
| Specified Value | High Permittivity (Class2) | | Specification | Temperature Range |
| | | BJ | B | -25 to +85°C |
| | | | X5R | -55 to +85°C |
| | | B7 | X7R | -55 to +125°C |
| | | C6 | X6S | -55 to +105°C |
| | | C7 | X7S | -55 to +125°C |
| | | LD(※) | X5R | -55 to +85°C |
| | | F | F | -25 to +85°C |
| Y5V | -30 to +85°C | | | |

Note: ※LD Low distortion high value multilayer ceramic capacitor

2. Storage Conditions

| | | | | |
|-----------------|-----------------------------------|---------------------|---------------|-------------------|
| Specified Value | Temperature Compensating (Class1) | Standard | -55 to +125°C | |
| | | High Frequency Type | | |
| Specified Value | High Permittivity (Class2) | | Specification | Temperature Range |
| | | BJ | B | -25 to +85°C |
| | | | X5R | -55 to +85°C |
| | | B7 | X7R | -55 to +125°C |
| | | C6 | X6S | -55 to +105°C |
| | | C7 | X7S | -55 to +125°C |
| | | LD(※) | X5R | -55 to +85°C |
| | | F | F | -25 to +85°C |
| Y5V | -30 to +85°C | | | |

Note: ※LD Low distortion high value multilayer ceramic capacitor

3. Rated Voltage

| | | | |
|-----------------|-----------------------------------|---------------------|---|
| Specified Value | Temperature Compensating (Class1) | Standard | 50VDC, 25VDC, 16VDC |
| | | High Frequency Type | 50VDC, 25VDC, 16VDC |
| | High Permittivity (Class2) | | 50VDC, 35VDC, 25VDC, 16VDC, 10VDC, 6.3VDC, 4VDC, 2.5VDC |

4. Withstanding Voltage (Between terminals)

| | | | |
|--------------------------|-----------------------------------|------------------------------|--------------------------------|
| Specified Value | Temperature Compensating (Class1) | Standard | No breakdown or damage |
| | | High Frequency Type | |
| Test Methods and Remarks | High Permittivity (Class2) | | |
| | Applied voltage | Class 1 Rated voltage × 3 | Class 2 Rated voltage × 2.5 |
| | Duration | 1 to 5 sec. | |
| | Charge/discharge current | 50mA max. | |

5. Insulation Resistance

| | | | |
|--------------------------|-----------------------------------|---------------------|---|
| Specified Value | Temperature Compensating (Class1) | Standard | 10000 MΩ min. |
| | | High Frequency Type | |
| Test Methods and Remarks | High Permittivity (Class2) Note 1 | | C ≤ 0.047 μF : 10000 MΩ min. C > 0.047 μF : 500MΩ · μF |
| | Applied voltage | : Rated voltage | |
| | Duration | : 60 ± 5 sec. | |
| Remarks | Charge/discharge current | : 50mA max. | |

▶ This catalog contains the typical specification only due to the limitation of space. When you consider the purchase of our products, please check our specification. For details of each product (characteristics graph, reliability information, precautions for use, and so on), see our Web site (<http://www.ty-top.com/>).

| 6. Capacitance (Tolerance) | | | | | |
|----------------------------|----------------------------------|------------------------|---|---------------------------|--|
| Specified Value | Temperature Compensating(Class1) | Standard | C□ | 0.2pF ≤ C ≤ 5pF : ±0.25pF | |
| | | | U□ | 0.2pF ≤ C ≤ 10pF : ±0.5pF | |
| | SL | C > 10pF : ±5% or ±10% | | | |
| High Permittivity (Class2) | High Frequency Type | CH | 0.2pF ≤ C ≤ 2pF | : ±0.1pF | |
| | | | C > 2pF | : ±5% | |
| High Permittivity (Class2) | | | BJ, B7, C6, C7, LD(※) : ±10% or ±20%, F : +80/-20% Note: ※LD Low distortion high value multilayer ceramic capacitor | | |
| Test Methods and Remarks | | | Class 1 | | |
| | | | Standard | High Frequency Type | |
| | Preconditioning | | None | | |
| | Measuring frequency | | Thermal treatment (at 150°C for 1hr) Note 2 | | |
| | Measuring voltage Note | | 1MHz ± 10% | | |
| Bias application | | 0.5 to 5Vrms | | | |
| | | Class 2 | | | |
| | | C ≤ 10 μF | C > 10 μF | | |
| Measuring frequency | | 1kHz ± 10% | | | |
| Measuring voltage Note | | 1 ± 0.2Vrms | | | |
| Bias application | | 0.5 ± 0.1Vrms | | | |
| | | None | | | |

| 7. Q or Dissipation Factor | | | | | |
|--|-----------------------------------|---------------|--|---------------------------------|--|
| Specified Value | Temperature Compensating(Class1) | Standard | C < 30pF : Q ≥ 400 + 20C C ≥ 30pF : Q ≥ 1000 (C: Nominal capacitance) | | |
| | | | High Frequency Type | Refer to detailed specification | |
| | High Permittivity (Class2) Note 1 | | BJ, B7, C6, C7: 2.5% max., F: 7% max. | | |
| Test Methods and Remarks | | | Class 1 | | |
| | | | Standard | High Frequency Type | |
| | Preconditioning | | None | | |
| | Measuring frequency | | Thermal treatment (at 150°C for 1hr) Note 2 | | |
| | Measuring voltage Note 1 | | 1MHz ± 10% | | |
| Bias application | | 0.5 to 5Vrms | | | |
| | | Class 2 | | | |
| | | C ≤ 10 μF | C > 10 μF | | |
| Measuring frequency | | 1kHz ± 10% | | | |
| Measuring voltage Note 1 | | 1 ± 0.2Vrms | | | |
| Bias application | | 0.5 ± 0.1Vrms | | | |
| | | None | | | |
| High Frequency Type Measuring equipment : HP4291A Measuring jig : HP16192A | | | | | |

| 8. Temperature Characteristic (Without voltage application) | | | | |
|---|---|-------------------------------|-------------------------------------|----------------|
| Specified Value | Temperature Compensating(Class1) | Standard | Temperature Characteristic [ppm/°C] | |
| | | | C□ : 0 | CG, CH, CJ, CK |
| | U□ : -750 | UJ, UK | Tolerance [ppm/°C] | |
| High Permittivity (Class2) | High Frequency Type | CH | H : ±30 | |
| | | | J : ±60 | |
| | | K : ±120 | | |
| | | SL : +350 to -1000 | | |
| | | K : ±250 | | |
| | | H : ±60 | | |
| | | C□ : 0 | | |
| | | CH | | |
| | | H : ±60 | | |
| | | H : ±60 | | |
| Note : ※LD Low distortion high value multilayer ceramic capacitor | | | | |
| Test Methods and Remarks | Class 1 Capacitance at 20°C and 85°C shall be measured in thermal equilibrium, and the temperature characteristic shall be calculated from the following equation. | | | |
| | $\frac{(C_{85} - C_{20})}{C_{20} \times \Delta T} \times 10^6 (\text{ppm}/^\circ\text{C}) \quad \Delta T = 65$ | | | |
| | Class 2 Capacitance at each step shall be measured in thermal equilibrium, and the temperature characteristic shall be calculated from the following equation. | | | |
| | Step | B, F | X5R, X7R, X6S, X7S, Y5V | |
| | 1 | Minimum operating temperature | | |
| 2 | 20°C | 25°C | | |
| 3 | Maximum operating temperature | | | |

▶ This catalog contains the typical specification only due to the limitation of space. When you consider the purchase of our products, please check our specification.
For details of each product (characteristics graph, reliability information, precautions for use, and so on), see our Web site (<http://www.ty-top.com/>).

| | |
|--|--|
| | $\frac{(C-C_2)}{C_2} \times 100(\%)$ <p>C : Capacitance in Step 1 or Step 3 C2 : Capacitance in Step 2</p> |
|--|--|

9. Deflection

| | | | |
|-----------------|-----------------------------------|---------------------|--|
| Specified Value | Temperature Compensating (Class1) | Standard | Appearance : No abnormality Capacitance change : Within $\pm 5\%$ or ± 0.5 pF, whichever is larger. |
| | | High Frequency Type | Appearance : No abnormality Capacitance change : Within ± 0.5 pF |
| | High Permittivity (Class2) | | Appearance : No abnormality Capacitance change : Within $\pm 12.5\%$ (BJ, B7, C6, C7, LD(※)) Within $\pm 30\%$ (F) Note: ※LD Low distortion high value multilayer ceramic capacitor |

| Test Methods and Remarks | <table border="1"> <tr> <th colspan="2">Multilayer Ceramic Capacitors</th> </tr> <tr> <td>042, 063, ※105 Type</td> <td>The other types</td> </tr> <tr> <td>Board</td> <td>Glass epoxy-resin substrate</td> </tr> <tr> <td>Thickness</td> <td>0.8mm / 1.6mm</td> </tr> <tr> <td>Warp</td> <td>1mm</td> </tr> <tr> <td>Duration</td> <td>10 sec.</td> </tr> </table> <p>※105 Type thickness, C: 0.2mm, P: 0.3mm.</p> | | Multilayer Ceramic Capacitors | | 042, 063, ※105 Type | The other types | Board | Glass epoxy-resin substrate | Thickness | 0.8mm / 1.6mm | Warp | 1mm | Duration | 10 sec. | <p>(Unit: mm) Capacitance measurement shall be conducted with the board bent</p> |
|--------------------------|--|--|-------------------------------|--|---------------------|-----------------|-------|-----------------------------|-----------|---------------|------|-----|----------|---------|--|
| | Multilayer Ceramic Capacitors | | | | | | | | | | | | | | |
| 042, 063, ※105 Type | The other types | | | | | | | | | | | | | | |
| Board | Glass epoxy-resin substrate | | | | | | | | | | | | | | |
| Thickness | 0.8mm / 1.6mm | | | | | | | | | | | | | | |
| Warp | 1mm | | | | | | | | | | | | | | |
| Duration | 10 sec. | | | | | | | | | | | | | | |

10. Body Strength

| | | | |
|--------------------------|---|---------------------|-----------------------|
| Specified Value | Temperature Compensating (Class1) | Standard | — |
| | | High Frequency Type | No mechanical damage. |
| | High Permittivity (Class2) | | — |
| Test Methods and Remarks | High Frequency Type Applied force : 5N Duration : 10 sec. | | |

11. Adhesive Strength of Terminal Electrodes

| Specified Value | Temperature Compensating (Class1) | Standard | No terminal separation or its indication. | | | | | | | | |
|-------------------------------|--|---------------------|---|--|---------------|------------------|---------------|---------|----------|-------------|--|
| | | High Frequency Type | | | | | | | | | |
| | High Permittivity (Class2) | | | | | | | | | | |
| Test Methods and Remarks | <table border="1"> <tr> <th colspan="2">Multilayer Ceramic Capacitors</th> </tr> <tr> <td>042, 063 Type</td> <td>105 Type or more</td> </tr> <tr> <td>Applied force</td> <td>2N / 5N</td> </tr> <tr> <td>Duration</td> <td>30 ± 5 sec.</td> </tr> </table> | | Multilayer Ceramic Capacitors | | 042, 063 Type | 105 Type or more | Applied force | 2N / 5N | Duration | 30 ± 5 sec. | |
| Multilayer Ceramic Capacitors | | | | | | | | | | | |
| 042, 063 Type | 105 Type or more | | | | | | | | | | |
| Applied force | 2N / 5N | | | | | | | | | | |
| Duration | 30 ± 5 sec. | | | | | | | | | | |

12. Solderability

| Specified Value | Temperature Compensating (Class1) | Standard | At least 95% of terminal electrode is covered by new solder. | | | | | | | | | | | | |
|--------------------------|---|---------------------|--|--|------------------|-------------|--------------|----------------|--------------------|-----------|-----------|----------|------------|--|--|
| | | High Frequency Type | | | | | | | | | | | | | |
| | High Permittivity (Class2) | | | | | | | | | | | | | | |
| Test Methods and Remarks | <table border="1"> <tr> <th colspan="2">Eutectic solder</th> <th>Lead-free solder</th> </tr> <tr> <td>Solder type</td> <td>H60A or H63A</td> <td>Sn-3.0Ag-0.5Cu</td> </tr> <tr> <td>Solder temperature</td> <td>230 ± 5°C</td> <td>245 ± 3°C</td> </tr> <tr> <td>Duration</td> <td colspan="2">4 ± 1 sec.</td> </tr> </table> | | Eutectic solder | | Lead-free solder | Solder type | H60A or H63A | Sn-3.0Ag-0.5Cu | Solder temperature | 230 ± 5°C | 245 ± 3°C | Duration | 4 ± 1 sec. | | |
| Eutectic solder | | Lead-free solder | | | | | | | | | | | | | |
| Solder type | H60A or H63A | Sn-3.0Ag-0.5Cu | | | | | | | | | | | | | |
| Solder temperature | 230 ± 5°C | 245 ± 3°C | | | | | | | | | | | | | |
| Duration | 4 ± 1 sec. | | | | | | | | | | | | | | |

▶ This catalog contains the typical specification only due to the limitation of space. When you consider the purchase of our products, please check our specification. For details of each product (characteristics graph, reliability information, precautions for use, and so on), see our Web site (<http://www.ty-top.com/>).

13. Resistance to Soldering

| | | | |
|-----------------|-----------------------------------|---------------------|--|
| Specified Value | Temperature Compensating (Class1) | Standard | Appearance : No abnormality Capacitance change : Within $\pm 2.5\%$ or $\pm 0.25\text{pF}$, whichever is larger. Q : Initial value Insulation resistance : Initial value Withstanding voltage (between terminals) : No abnormality |
| | | High Frequency Type | Appearance : No abnormality Capacitance change : Within $\pm 2.5\%$ Q : Initial value Insulation resistance : Initial value Withstanding voltage (between terminals) : No abnormality |
| | High Permittivity (Class2) Note 1 | | Appearance : No abnormality Capacitance change : Within $\pm 7.5\%$ (BJ, B7, C6, C7, LD(※)) Within $\pm 20\%$ (F) Dissipation factor : Initial value Insulation resistance : Initial value Withstanding voltage (between terminals): No abnormality Note: ※LD Low distortion high value multilayer ceramic capacitor |

| | | | | |
|--------------------------|-----------------|--|---|---|
| Test Methods and Remarks | Class 1 | | | |
| | | 042, 063 Type | 105 Type | |
| | Preconditioning | None | | |
| | Preheating | 150°C, 1 to 2 min. | 80 to 100°C, 2 to 5 min. 150 to 200°C, 2 to 5 min. | |
| | Solder temp. | 270 \pm 5°C | | |
| | Duration | 3 \pm 0.5 sec. | | |
| | Recovery | 6 to 24 hrs (Standard condition) Note 5 | | |
| | Class 2 | | | |
| | | 042, 063 Type | 105, 107, 212 Type | 316, 325 Type |
| | Preconditioning | Thermal treatment (at 150°C for 1 hr) Note 2 | | |
| | Preheating | 150°C, 1 to 2 min. | 80 to 100°C, 2 to 5 min. 150 to 200°C, 2 to 5 min. | 80 to 100°C, 5 to 10 min. 150 to 200°C, 5 to 10 min. |
| | Solder temp. | 270 \pm 5°C | | |
| | Duration | 3 \pm 0.5 sec. | | |
| | Recovery | 24 \pm 2 hrs (Standard condition) Note 5 | | |

14. Temperature Cycle (Thermal Shock)

| | | | |
|-----------------|-----------------------------------|---------------------|---|
| Specified Value | Temperature Compensating (Class1) | Standard | Appearance : No abnormality Capacitance change : Within $\pm 2.5\%$ or $\pm 0.25\text{pF}$, whichever is larger. Q : Initial value Insulation resistance : Initial value Withstanding voltage (between terminals) : No abnormality |
| | | High Frequency Type | Appearance : No abnormality Capacitance change : Within $\pm 0.25\text{pF}$ Q : Initial value Insulation resistance : Initial value Withstanding voltage (between terminals) : No abnormality |
| | High Permittivity (Class2) Note 1 | | Appearance : No abnormality Capacitance change : Within $\pm 7.5\%$ (BJ, B7, C6, C7, LD(※)) Within $\pm 20\%$ (F) Dissipation factor : Initial value Insulation resistance : Initial value Withstanding voltage (between terminals) : No abnormality Note: ※LD Low distortion high value multilayer ceramic capacitor |

| | | | | |
|--------------------------|---|--|---|-------------|
| Test Methods and Remarks | Class 1 | | Class 2 | |
| | Preconditioning | None | Thermal treatment (at 150°C for 1 hr) Note 2 | |
| | 1 cycle | Step | Temperature (°C) | Time (min.) |
| | | 1 | Minimum operating temperature | 30 \pm 3 |
| | | 2 | Normal temperature | 2 to 3 |
| | | 3 | Maximum operating temperature | 30 \pm 3 |
| 4 | Normal temperature | 2 to 3 | | |
| Number of cycles | 5 times | | | |
| Recovery | 6 to 24 hrs (Standard condition) Note 5 | 24 \pm 2 hrs (Standard condition) Note 5 | | |

► This catalog contains the typical specification only due to the limitation of space. When you consider the purchase of our products, please check our specification.
For details of each product (characteristics graph, reliability information, precautions for use, and so on), see our Web site (<http://www.ty-top.com/>).

15. Humidity (Steady State)

| | | | | |
|--------------------------|-----------------------------------|--|---|---|
| Specified Value | Temperature Compensating (Class1) | Standard | Appearance | : No abnormality |
| | | | Capacitance change | : Within $\pm 5\%$ or $\pm 0.5\text{pF}$, whichever is larger. |
| | High Frequency Type | High Permittivity (Class2) Note 1 | Q | : $C < 10\text{pF}$: $Q \geq 200 + 10C$ $10 \leq C < 30\text{pF}$: $Q \geq 275 + 2.5C$ $C \geq 30\text{pF}$: $Q \geq 350$ (C: Nominal capacitance) |
| Insulation resistance | | | : 1000 M Ω min. | |
| Test Methods and Remarks | | | Appearance | : No abnormality |
| | | | Capacitance change | : Within $\pm 0.5\text{pF}$, Insulation resistance : 1000 M Ω min. |
| | Class 1 | | Class 2 | |
| | Standard | | High Frequency Type | |
| | Preconditioning | | All items | |
| | Temperature | | Thermal treatment (at 150°C for 1 hr) Note 2 | |
| | Humidity | | 40 $\pm 2^\circ\text{C}$ | |
| Duration | | 90 to 95%RH | | |
| Recovery | | 500 + 24 / - 0 hrs | | |
| | | 6 to 24 hrs (Standard condition) Note 5 | | |
| | | 24 ± 2 hrs (Standard condition) Note 5 | | |

16. Humidity Loading

| | | | | |
|--------------------------|-----------------------------------|---|--|--|
| Specified Value | Temperature Compensating (Class1) | Standard | Appearance | : No abnormality |
| | | | Capacitance change | : Within $\pm 7.5\%$ or $\pm 0.75\text{pF}$, whichever is larger. |
| | High Frequency Type | High Permittivity (Class2) Note 1 | Q | : $C < 30\text{pF}$: $Q \geq 100 + 10C/3$ $C \geq 30\text{pF}$: $Q \geq 200$ (C: Nominal capacitance) |
| Insulation resistance | | | : 500 M Ω min. | |
| Test Methods and Remarks | | | Appearance | : No abnormality |
| | | | Capacitance change | : Within $\pm 12.5\%$ (BJ, B7, C6, C7, LD(※)) Within $\pm 30\%$ (F) |
| | | | Dissipation factor | : 5.0% max. (BJ, B7, C6, C7, LD(※)) 11.0% max. (F) |
| | | | Insulation resistance | : 25 M Ω μF or 500 M Ω , whichever is smaller. |
| | | | Note: ※LD Low distortion high value multilayer ceramic capacitor | |
| | Class 1 | | Class 2 | |
| | Standard | | High Frequency Type | |
| Preconditioning | | All items | | |
| Temperature | | Voltage treatment (Rated voltage are applied for 1 hour at 40°C) Note 3 | | |
| Humidity | | 40 $\pm 2^\circ\text{C}$ | | |
| Duration | | 90 to 95%RH | | |
| Applied voltage | | 500 + 24 / - 0 hrs | | |
| Charge/discharge current | | Rated voltage | | |
| Recovery | | 50mA max. | | |
| | | 6 to 24 hrs (Standard condition) Note 5 | | |
| | | 24 ± 2 hrs (Standard condition) Note 5 | | |

► This catalog contains the typical specification only due to the limitation of space. When you consider the purchase of our products, please check our specification.
For details of each product (characteristics graph, reliability information, precautions for use, and so on), see our Web site (<http://www.ty-top.com/>).

17. High Temperature Loading

| | | | |
|-----------------|-----------------------------------|---------------------|--|
| Specified Value | Temperature Compensating (Class1) | Standard | Appearance : No abnormality Capacitance change : Within $\pm 3\%$ or $\pm 0.3\text{pF}$, whichever is larger. Q : $C < 10\text{pF}$: $Q \geq 200 + 10C$ $10 \leq C < 30\text{pF}$: $Q \geq 275 + 2.5C$ $C \geq 30\text{pF}$: $Q \geq 350$ (C: Nominal capacitance) Insulation resistance : $1000 \text{ M}\Omega$ min. |
| | | High Frequency Type | Appearance : No abnormality Capacitance change : Within $\pm 3\%$ or $\pm 0.3\text{pF}$, whichever is larger. Insulation resistance : $1000 \text{ M}\Omega$ min. |
| | High Permittivity (Class2) Note 1 | | Appearance : No abnormality Capacitance change : Within $\pm 12.5\%$ (BJ, B7, C6, C7, LD(※)) Within $\pm 30\%$ (F) Dissipation factor : 5.0% max. (BJ, B7, C6, C7, LD(※)) 11.0% max. (F) Insulation resistance : $50 \text{ M}\Omega \mu\text{F}$ or $1000 \text{ M}\Omega$, whichever is smaller. Note: ※LD Low distortion high value multilayer ceramic capacitor |

| | | | | | | |
|--------------------------|--------------------------|---------------------------------------|---------------------|---|----|--------|
| Test Methods and Remarks | | Class 1 | | Class 2 | | |
| | | Standard | High Frequency Type | BJ, LD(※), F | C6 | B7, C7 |
| | Preconditioning | None | | Voltage treatment (Twice the rated voltage shall be applied for 1 hour at 85°C, 105°C or 125°C) Note 3, 4 | | |
| | Temperature | Maximum operating temperature | | Maximum operating temperature | | |
| | Duration | 1000 + 48 / - 0 hrs | | 1000 + 48 / - 0 hrs | | |
| | Applied voltage | Rated voltage $\times 2$ Note 4 | | Rated voltage $\times 2$ Note 4 | | |
| | Charge/discharge current | 50mA max. | | 50mA max. | | |
| | Recovery | 6 to 24hr (Standard condition) Note 5 | | 24 \pm 2 hrs (Standard condition) Note 5 | | |

Note: ※LD Low distortion high value multilayer ceramic capacitor

Note 1 The figures indicate typical specifications. Please refer to individual specifications in detail.

Note 2 Thermal treatment : Initial value shall be measured after test sample is heat-treated at $150 \pm 0 / - 10^\circ\text{C}$ for an hour and kept at room temperature for 24 ± 2 hours.

Note 3 Voltage treatment : Initial value shall be measured after test sample is voltage-treated for an hour at both the temperature and voltage specified in the test conditions, and kept at room temperature for 24 ± 2 hours.

Note 4 150% of rated voltage is applicable to some items. Please refer to their specifications for further information.

Note 5 Standard condition: Temperature: 5 to 35°C, Relative humidity: 45 to 85 % RH, Air pressure: 86 to 106kPa When there are questions concerning measurement results, in order to provide correlation data, the test shall be conducted under the following condition.

Temperature: $20 \pm 2^\circ\text{C}$, Relative humidity: 60 to 70 % RH, Air pressure: 86 to 106kPa Unless otherwise specified, all the tests are conducted under the "standard condition".

Super Low Distortion Multilayer Ceramic Capacitors (CFCAP™)

RELIABILITY DATA

1. Operating Temperature Range

| | |
|-----------------|---------------|
| Specified Value | -55 to +125°C |
|-----------------|---------------|

2. Storage Temperature Range

| | |
|-----------------|---------------|
| Specified Value | -55 to +125°C |
|-----------------|---------------|

3. Rated Voltage

| | |
|-----------------|---|
| Specified Value | 6.3VDC, 10VDC, 16VDC, 25VDC, 35VDC, 50VDC |
|-----------------|---|

4. Dielectric Withstanding Voltage (Between terminals)

| | | |
|--------------------------|--------------------------|---------------------|
| Specified Value | No breakdown or damage | |
| Test Methods and Remarks | Applied voltage | : Rated voltage × 3 |
| | Duration | : 1 to 5 sec. |
| | Charge/discharge current | : 50mA max. |

5. Insulation Resistance

| | | |
|--------------------------|---|-----------------|
| Specified Value | 10000 MΩ or 500MΩ μ F, whichever is smaller | |
| Test Methods and Remarks | Applied voltage | : Rated voltage |
| | Duration | : 60±5 sec. |
| | Charge/discharge current | : 50mA max. |

6. Capacitance (Tolerance)

| | | |
|--------------------------|---------------------|-------------|
| Specified Value | ±10% | |
| Test Methods and Remarks | Measuring frequency | : 1kHz±10% |
| | Measuring voltage | : 1±0.2Vrms |
| | Bias application | : None |

7. Dissipation Factor

| | | |
|--------------------------|---------------------|-------------|
| Specified Value | 0.1%max | |
| Test Methods and Remarks | Measuring frequency | : 1kHz±10% |
| | Measuring voltage | : 1±0.2Vrms |
| | Bias application | : None |

8. Bending Strength

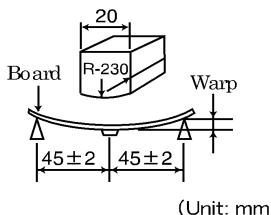
| | |
|--------------------------|---|
| Specified Value | Appearance : No abnormality Capacitance change : ±5% |
| Test Methods and Remarks | Warp : 1mm Speed : 0.5mm/second Duration : 10 seconds Test board : glass epoxy resin substrate Thickness : 1.6mm |
| |  <p>(Unit: mm)</p> <p>Capacitance measurement shall be conducted with the board bent.</p> |

9. Adhesive Force of Terminal Electrodes

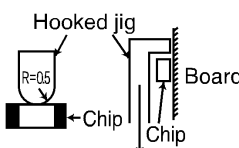
| | | |
|--------------------------|---|---|
| Specified Value | Terminal electrodes shall be no exfoliation or a sign of exfoliation. | |
| Test Methods and Remarks | Applied force : 5N Duration : 30 ± 5 seconds |  |

▶ This catalog contains the typical specification only due to the limitation of space. When you consider the purchase of our products, please check our specification. For details of each product (characteristics graph, reliability information, precautions for use, and so on), see our Web site (<http://www.ty-top.com/>).

| 10. Solderability | | | |
|---|--|---|------------------|
| Specified Value | At least 95% of terminal electrode is covered by new solder. | | |
| Test Methods and Remarks | | Eutectic solder | Lead-free solder |
| | Solder type | H60A or H63A | Sn-3.0Ag-0.5Cu |
| | Solder temperature | 230±5°C | 245±3°C |
| | Duration | 4±1 sec. | |
| 11. Resistance to Soldering Heat | | | |
| Specified Value | Appearance | : No abnormality | |
| | Capacitance change | : ±2.5% max. | |
| | Dissipation factor | : Initial value | |
| | Insulation resistance | : Initial value | |
| | Withstanding voltage | (between terminals) : No abnormality | |
| Test Methods and Remarks | Solder temp. | : 270 ±5°C | |
| | Duration | : 3 ±0.5 sec. | |
| | Preheating conditions | : 80 to 100°C, 2 to 5 min. or 5 to 10 min. 150 to 200°C, 2 to 5 min. or 5 to 10 min. | |
| | Measurement shall be conducted | : 24±2hrs under the standard condition Note1 | |
| 12. Temperature Cycle (Thermal Shock) | | | |
| Specified Value | Appearance | : No abnormality | |
| | Capacitance change | : ±2.5% max | |
| | Dissipation factor | : Initial value | |
| | Insulation resistance | : Initial value | |
| | Withstanding voltage | (between terminals): No abnormality | |
| Test Methods and Remarks | Conditions for 1 cycle | | |
| | Step | temperature (°C) | Time (min.) |
| | 1 | Minimum operating temperature | 30±3 min. |
| | 2 | Normal temperature | 2 to 3 min. |
| | 3 | Maximum operating temperature | 30±3 min. |
| | 4 | Normal temperature | 2 to 3 min. |
| Number of cycles: 5 times | | | |
| Measurement shall be conducted : 24±2hrs under the standard condition Note1 | | | |
| 13. Humidity (Steady state) | | | |
| Specified Value | Appearance | : No abnormality | |
| | Capacitance change | : ±5% max | |
| | Dissipation factor | : 0.5% max | |
| | Insulation resistance | : 50MΩ μF or 1000MΩ, whichever is smaller | |
| Test Methods and Remarks | Temperature | : 40±2°C | |
| | Humidity | : 90 to 95% RH | |
| | Duration | : 500 +24/-0 hrs | |
| | Measurement shall be conducted | : 24 ±2hrs under the standard condition Note1 | |
| 14. Humidity Loading | | | |
| Specified Value | Appearance | : No abnormality | |
| | Capacitance change | : ±7.5% max | |
| | Dissipation factor | : 0.5% max | |
| | Insulation resistance | : 25MΩ μF or 500MΩ, whichever is smaller | |
| Test Methods and Remarks | According to JIS C 5102 clause 9.9. | | |
| | Temperature | : 40±2°C | |
| | Humidity | : 90 to 95% RH | |
| | Duration | : 500 +24/-0 hrs | |
| | Applied voltage | : Rated voltage | |
| | Charge/discharge current | : 50mA max | |
| | Measurement shall be conducted | : 24 ±2hrs under the standard condition Note1 | |

▶ This catalog contains the typical specification only due to the limitation of space. When you consider the purchase of our products, please check our specification.
For details of each product (characteristics graph, reliability information, precautions for use, and so on), see our Web site (<http://www.ty-top.com/>).

15. High Temperature Loading

| | | |
|--------------------------------|--|---|
| Specified Value | Appearance | : No abnormality |
| | Capacitance change | : $\pm 3\%$ max |
| | Dissipation factor | : 0.35% max |
| | Insulation resistance | : 50M Ω μ F or 1000M Ω , whichever is smaller |
| Test Methods and Remarks | According to JIS C 5102 clause 9.10. | |
| | Temperature | : Maximum operating temperature |
| | Duration | : 1000 +48/−0 hrs |
| | Applied voltage | : Rated voltage x 2 |
| | Charge/discharge current | : 50mA max |
| Measurement shall be conducted | : 24 \pm 2hrs under the standard condition | Note1 |

Note1 Standard condition: Temperature: 5 to 35°C, Relative humidity: 45 to 85 % RH, Air pressure: 86 to 106kPa

When there are questions concerning measurement results, in order to provide correlation data, the test shall be conducted under the following condition.

Temperature: 20 \pm 2°C, Relative humidity: 60 to 70 % RH, Air pressure: 86 to 106kPa

Unless otherwise specified, all the tests are conducted under the "standard condition".

Medium-High Voltage Multilayer Ceramic Capacitor

RELIABILITY DATA

| 1. Operating Temperature Range | | |
|--|---|--|
| Specified Value | Temperature Compensating(Class1) | CG : -55~+125°C |
| | High Permittivity (Class2) | X7R, X7S : -55 to +125°C X5R : -55 to +85°C B : -25 to +85°C SD : -55~+125°C |
| 2. Storage Temperature Range | | |
| Specified Value | Temperature Compensating(Class1) | CG : -55~+125°C |
| | High Permittivity (Class2) | X7R, X7S : -55 to +125°C X5R : -55 to +85°C B : -25 to +85°C SD : -55~+125°C |
| 3. Rated Voltage | | |
| Specified Value | Temperature Compensating(Class1) | 100VDC(HMK) |
| | High Permittivity (Class2) | 100VDC(HMK), 250VDC(QMK), 630VDC(SMK) |
| 4. Withstanding Voltage(Between terminals) | | |
| Specified Value | No breakdown or damage | |
| Test Methods and Remarks | Applied voltage : Rated voltage × 2.5(HMK), Rated voltage × 2(QMK), Rated voltage × 1.2(SMK) Duration : 1 to 5sec. Charge/discharge current : 50mA max. | |
| 5. Insulation Resistance | | |
| Specified Value | Temperature Compensating(Class1) | 10000 MΩ min. |
| | High Permittivity (Class2) | 100MΩ · μF or 10GΩ, whichever is smaller. |
| Test Methods and Remarks | Applied voltage : Rated voltage(HMK, QMK), 500V(SMK) Duration : 60±5sec. Charge/discharge current : 50mA max. | |
| 6. Capacitance (Tolerance) | | |
| Specified Value | Temperature Compensating(Class1) | 0.2pF ≤ C ≤ 5pF : ±0.25pF 0.2pF ≤ C ≤ 10pF : ±0.5pF C > 10pF : ±5% or ±10% |
| | High Permittivity (Class2) | ±10%, ±20% |
| Test Methods and Remarks | Measuring frequency : 1kHz ± 10% Measuring voltage : 1 ± 0.2Vrms Bias application : None | |
| 7. Q or Dissipation Factor | | |
| Specified Value | Temperature Compensating(Class1) | C < 30pF : Q ≥ 400 + 20C C ≥ 30pF : Q ≥ 1000 (C: Nominal capacitance) |
| | High Permittivity (Class2) | 3.5%max(HMK), 2.5%max(QMK, SMK) |
| Test Methods and Remarks | Temperature Compensating(Class1) | Measuring frequency : 1MHz ± 10% Measuring voltage : 0.5~5Vrms Bias application : None |
| | High Permittivity (Class2) | Measuring frequency : 1kHz ± 10% Measuring voltage : 1 ± 0.2Vrms Bias application : None |

▶ This catalog contains the typical specification only due to the limitation of space. When you consider the purchase of our products, please check our specification. For details of each product (characteristics graph, reliability information, precautions for use, and so on), see our Web site (<http://www.ty-top.com/>).

| 8. Temperature Characteristic of Capacitance | | | | | | | | | | | | | |
|--|---|--|------|-----|------------------|---|-------------------------------|--|---|------|------|---|-------------------------------|
| Specified Value | Temperature Compensating(Class1) | CG : $0 \pm 30 \text{ppm}/^\circ\text{C} (-55 \sim +125^\circ\text{C})$ | | | | | | | | | | | |
| | High Permittivity (Class2) | B : $\pm 10\% (-25 \text{ to } +85^\circ\text{C})$ X5R : $\pm 15\% (-55 \text{ to } +85^\circ\text{C})$ X7R : $\pm 15\% (-55 \text{ to } +125^\circ\text{C})$ X7S : $\pm 22\% (-55 \text{ to } +125^\circ\text{C})$ SD : - ($-55 \sim +125^\circ\text{C}$) | | | | | | | | | | | |
| Test Methods and Remarks | Capacitance value at each step shall be measured in thermal equilibrium, and the temperature characteristic shall be calculated from the following equation. | | | | | | | | | | | | |
| | <table border="1"> <thead> <tr> <th>Step</th> <th>CG、</th> <th>B、X5R、X7R、X7S、SD</th> </tr> </thead> <tbody> <tr> <td>1</td> <td colspan="2">Minimum operating temperature</td> </tr> <tr> <td>2</td> <td>20°C</td> <td>25°C</td> </tr> <tr> <td>3</td> <td colspan="2">Maximum operating temperature</td> </tr> </tbody> </table> | | Step | CG、 | B、X5R、X7R、X7S、SD | 1 | Minimum operating temperature | | 2 | 20°C | 25°C | 3 | Maximum operating temperature |
| Step | CG、 | B、X5R、X7R、X7S、SD | | | | | | | | | | | |
| 1 | Minimum operating temperature | | | | | | | | | | | | |
| 2 | 20°C | 25°C | | | | | | | | | | | |
| 3 | Maximum operating temperature | | | | | | | | | | | | |
| $\frac{(C-C_2)}{C_2} \times 100(\%)$ <p>C : Capacitance value in Step 1 or Step 3 C2 : Capacitance value in Step 2</p> | | | | | | | | | | | | | |

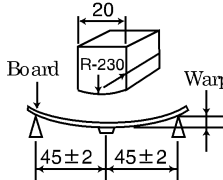
| 9. Deflection | | |
|--------------------------|--|---|
| Specified Value | Temperature Compensating(Class1) | Appearance : No abnormality Capacitance change : Within $\pm 5\%$ or $\pm 0.5 \text{ pF}$, whichever is larger. |
| | High Permittivity (Class2) | Appearance : No abnormality Capacitance change : Within $\pm 10\%$ |
| Test Methods and Remarks | Warp : 1mm Duration : 10sec. Test board : Glass epoxy-resin substrate Thickness : 1.6mm |  <p>(Unit: mm)</p> |
| | Capacitance measurement shall be conducted with the board bent. | |

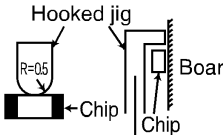
| 10. Adhesive Strength of Terminal Electrodes | | |
|--|---|---|
| Specified Value | Temperature Compensating(Class1) | No terminal separation or its indication. |
| | High Permittivity (Class2) | |
| Test Methods and Remarks | Applied force : 5N Duration : $30 \pm 5 \text{sec.}$ |  |
| | | |

| 11. Solderability | | | |
|--------------------------|----------------------------------|---|---------------------------|
| Specified Value | Temperature Compensating(Class1) | At least 95% of terminal electrode is covered by new solder | |
| | High Permittivity (Class2) | | |
| Test Methods and Remarks | | Eutectic solder | Lead-free solder |
| | Solder type | H60A or H63A | Sn-3.0Ag-0.5Cu |
| | Solder temperature | $230 \pm 5^\circ\text{C}$ | $245 \pm 3^\circ\text{C}$ |
| | Duration | $4 \pm 1 \text{ sec.}$ | |

| 12. Resistance to Soldering | | |
|-----------------------------|----------------------------------|---|
| Specified Value | Temperature Compensating(Class1) | Appearance : No abnormality Capacitance change : Within $\pm 2.5\%$ or $\pm 0.25 \text{pF}$, whichever is larger.(HMK) Q : Initial value Insulation resistance : Initial value Withstanding voltage (between terminals) : No abnormality |
| | High Permittivity (Class2) | Appearance : No abnormality Capacitance change : Within $\pm 15\%$ (HMK), $\pm 10\%$ (QMK, SMK) Dissipation facto : Initial value Insulation resistance : Initial value Withstanding voltage (between terminals) : No abnormality |

▶ This catalog contains the typical specification only due to the limitation of space. When you consider the purchase of our products, please check our specification. For details of each product (characteristics graph, reliability information, precautions for use, and so on), see our Web site (<http://www.ty-top.com/>).

| | | |
|--------------------------|----------------------------------|--|
| Test Methods and Remarks | Temperature Compensating(Class1) | |
| | Preconditioning | None |
| | Solder temperature | 270±5°C |
| | Duration | 3±0.5sec. |
| | Preheating conditions | 80 to 100°C, 2 to 5 min. 150 to 200°C, 2 to 5min. |
| | Recovery | 24±2hrs under the standard condition Note3 |
| | High Permittivity (Class2) | |
| | Preconditioning | Thermal treatment(at 150°C for 1hr) Note1 |
| | Solder temperature | 270±5°C |
| | Duration | 3±0.5sec. |
| | Preheating conditions | 80 to 100°C, 2 to 5 min. 150 to 200°C, 2 to 5min. |
| | Recovery | 24±2hrs under the standard condition Note3 |

13. Temperature Cycle (Thermal Shock)

| | | |
|-----------------|----------------------------------|---|
| Specified Value | Temperature Compensating(Class1) | Appearance : No abnormality Capacitance change : Within ±2.5% or ±0.25pF, whichever is larger.(HMK) Q : Initial value Insulation resistance : Initial value Withstanding voltage (between terminals) : No abnormality |
| | High Permittivity (Class2) | Appearance : No abnormality Capacitance change : Within±15%(HMK), ±10%(QMK, SMK) Dissipation facto : Initial value Insulation resistance : Initial value Withstanding voltage (between terminals) : No abnormality |

| | | | | |
|--------------------------|---|--------------------------------------|---|------------|
| Test Methods and Remarks | Class 1 | | Class 2 | |
| | Preconditioning | None | Thermal treatment (at 150°C for 1 hr) Note 2 | |
| | 1 cycle | Step | Temperature(°C) | Time(min.) |
| | | 1 | Minimum operating temperature | 30±3 |
| | | 2 | Normal temperature | 2 to 3 |
| | | 3 | Maximum operating temperature | 30±3 |
| 4 | Normal temperature | 2 to 3 | | |
| Number of cycles | 5 times | | | |
| Recovery | 6 to 24 hrs (Standard condition) Note 3 | 24±2 hrs (Standard condition) Note 3 | | |

14. Humidity (Steady state)

| | | |
|-----------------|----------------------------------|---|
| Specified Value | Temperature Compensating(Class1) | Appearance : No abnormality Capacitance change : Within ±5% or ±0.5pF, whichever is larger.(HMK) Q : C<10pF : Q≥200+10C 10≤C<30pF : Q≥275+2.5C C≥30pF:Q≥350 (C:Nominal capacitance) Insulation resistance : 1000 MΩ min. |
| | High Permittivity (Class2) | Appearance : No abnormality Capacitance change : Within±15% Dissipation factor : 7%max(HMK), 5%max(QMK, SMK). Insulation resistance : 25MΩ μF or 1000MΩ, whichever is smaller. |

| | | | |
|--------------------------|-----------------|---|--|
| Test Methods and Remarks | Class 1 | | Class 2 |
| | Preconditioning | None | Thermal treatment(at 150°C for 1 hr) Note 1 |
| | Temperature | 40±2°C | 40±2°C |
| | Humidity | 90 to 95%RH | 90 to 95%RH |
| | Duration | 500+24/-0 hrs | 500+24/-0 hrs |
| | Recovery | 6 to 24 hrs (Standard condition) Note 3 | 24±2 hrs (Standard condition) Note 3 |

▶ This catalog contains the typical specification only due to the limitation of space. When you consider the purchase of our products, please check our specification.
For details of each product (characteristics graph, reliability information, precautions for use, and so on), see our Web site (<http://www.ty-top.com/>).

| 15. Humidity Loading | | | |
|--------------------------|---|--|---|
| Specified Value | Temperature Compensating(Class1) | Appearance : No abnormality Capacitance change : Within $\pm 7.5\%$ or $\pm 0.75\text{pF}$, whichever is larger(HMK). Q : $C < 30\text{pF} : Q \geq 100 + 10C/3$ $C \geq 30\text{pF} : Q \geq 200$ (C:Nominal capacitance) Insulation resistance : $500 \text{ M}\Omega$ min. | |
| | High Permittivity (Class2) | Appearance : No abnormality Capacitance change : Within $\pm 15\%$ Dissipation factor : $7\%_{\text{max}}$ (HMK), $5\%_{\text{max}}$ (QMK, SMK). Insulation resistance : $10 \text{M}\Omega \mu\text{F}$ or $500 \text{M}\Omega$, whichever is smaller. | |
| Test Methods and Remarks | According to JIS 5102 clause 9.9. | | |
| | | Class 1 | Class 2 |
| | Preconditioning | None | Voltage treatment (Rated voltage are applied for 1 hour at 40°C) Note 2 |
| | Temperature | $40 \pm 2^\circ\text{C}$ | $40 \pm 2^\circ\text{C}$ |
| | Humidity | 90 to 95%RH | 90 to 95%RH |
| | Duration | $500 + 24 / - 0$ hrs | $500 + 24 / - 0$ hrs |
| | Applied voltage | Rated voltage | Rated voltage |
| | Charge/discharge current | 50mA max. | 50mA max. |
| Recovery | 6 to 24 hrs (Standard condition) Note 3 | 24 ± 2 hrs (Standard condition) Note 3 | |

| 16. High Temperature Loading | | | |
|------------------------------|------------------------------------|--|---|
| Specified Value | Temperature Compensating(Class1) | Appearance : No abnormality Capacitance change : Within $\pm 7.5\%$ or $\pm 0.75\text{pF}$, whichever is larger.(HMK) Q : $C < 30\text{pF} : Q \geq 100 + 10C/3$ $C \geq 30\text{pF} : Q \geq 200$ (C:Nominal capacitance) Insulation resistance : $500 \text{ M}\Omega$ min. | |
| | High Permittivity (Class2) | Appearance : No abnormality Capacitance change : Within $\pm 15\%$ Dissipation factor : $7\%_{\text{max}}$ (HMK), $5\%_{\text{max}}$ (QMK, SMK). Insulation resistance : $50 \text{M}\Omega \mu\text{F}$ or $1000 \text{M}\Omega$, whichever is smaller. | |
| Test Methods and Remarks | According to JIS 5102 clause 9.10. | | |
| | | Class 1 | Class 2 |
| | Preconditioning | None | Voltage treatment (Twice the rated voltage shall be applied for 1 hour at 85°C , 105°C or 125°C) Note 3, 4 |
| | Temperature | Maximum operating temperature | Maximum operating temperature |
| | Duration | $1000 + 48 / - 0$ hrs | $1000 + 48 / - 0$ hrs |
| | Applied voltage | Rated voltage $\times 2$ (HMK) | Rated voltage $\times 2$ (HMK), Rated voltage $\times 1.5$ (QMK), Rated voltage $\times 1.2$ (SMK) |
| | Charge/discharge current | 50mA max. | 50mA max. |
| | Recovery | 6 to 24hr (Standard condition) Note 3 | 24 ± 2 hrs (Standard condition) Note 3 |

Note1 Thermal treatment : Initial value shall be measured after test sample is heat-treated at $150 \pm 0 / - 10^\circ\text{C}$ for an hour and kept at room temperature for 24 ± 2 hours.

Note2 Voltage treatment : Initial value shall be measured after test sample is voltage-treated for an hour at both the temperature and voltage specified in the test conditions, and kept at room temperature for 24 ± 2 hours.

Note3 Standard condition : Temperature: 5 to 35°C , Relative humidity: 45 to 85% RH, Air pressure: 86 to 106kPa
When there are questions concerning measurement results, in order to provide correlation data, the test shall be conducted under the following condition.
Temperature: $20 \pm 2^\circ\text{C}$, Relative humidity: 60 to 70% RH, Air pressure: 86 to 106kPa
Unless otherwise specified, all the tests are conducted under the "standard condition".

Precautions on the use of Multilayer Ceramic Capacitors

PRECAUTIONS

1. Circuit Design

- ◆Verification of operating environment, electrical rating and performance**
1. A malfunction of equipment in fields such as medical, aerospace, nuclear control, etc. may cause serious harm to human life or have severe social ramifications.
Therefore, any capacitors to be used in such equipment may require higher safety and reliability, and shall be clearly differentiated from them used in general purpose applications.
- ◆Operating Voltage (Verification of Rated voltage)**
1. The operating voltage for capacitors must always be their rated voltage or less.
If an AC voltage is loaded on a DC voltage, the sum of the two peak voltages shall be the rated voltage or less.
For a circuit where an AC or a pulse voltage may be used, the sum of their peak voltages shall also be the rated voltage or less.
 2. Even if an applied voltage is the rated voltage or less reliability of capacitors may be deteriorated in case that either a high frequency AC voltage or a pulse voltage having rapid rise time is used in a circuit.

2. PCB Design

- ◆Pattern configurations (Design of Land-patterns)**
1. When capacitors are mounted on PCBs, the amount of solder used (size of fillet) can directly affect the capacitor performance.
Therefore, the following items must be carefully considered in the design of land patterns:
 - (1) Excessive solder applied can cause mechanical stresses which lead to chip breaking or cracking. Therefore, please consider appropriate land-patterns for proper amount of solder.
 - (2) When more than one component are jointly soldered onto the same land, each component's soldering point shall be separated by solder-resist.
- ◆Pattern configurations (Capacitor layout on PCBs)**
- After capacitors are mounted on boards, they can be subjected to mechanical stresses in subsequent manufacturing processes (PCB cutting, board inspection, mounting of additional parts, assembly into the chassis, wave soldering of the boards, etc.). For this reason, land pattern configurations and positions of capacitors shall be carefully considered to minimize stresses.

- ◆Pattern configurations (Design of Land-patterns)**
- The following diagrams and tables show some examples of recommended land patterns to prevent excessive solder amounts.

(1) Recommended land dimensions for typical chip capacitors

● Multilayer Ceramic Capacitors : Recommended land dimensions (unit: mm)

Wave-soldering

| Type | 107 | 212 | 316 | 325 | |
|------|------------|------------|------------|------------|-----|
| Size | L | 1.6 | 2.0 | 3.2 | 3.2 |
| | W | 0.8 | 1.25 | 1.6 | 2.5 |
| A | 0.8 to 1.0 | 1.0 to 1.4 | 1.8 to 2.5 | 1.8 to 2.5 | |
| B | 0.5 to 0.8 | 0.8 to 1.5 | 0.8 to 1.7 | 0.8 to 1.7 | |
| C | 0.6 to 0.8 | 0.9 to 1.2 | 1.2 to 1.6 | 1.8 to 2.5 | |

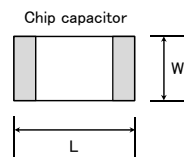
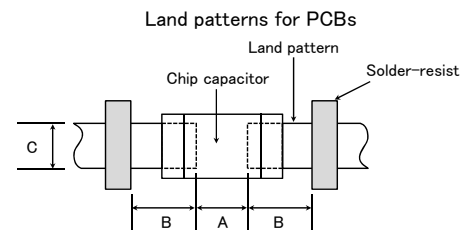

Reflow-soldering

| Type | 042 | 063 | 105 | 107 | 212 | 316 | 325 | 432 | |
|------|--------------|--------------|--------------|------------|------------|------------|------------|------------|-----|
| Size | L | 0.4 | 0.6 | 1.0 | 1.6 | 2.0 | 3.2 | 3.2 | 4.5 |
| | W | 0.2 | 0.3 | 0.5 | 0.8 | 1.25 | 1.6 | 2.5 | 3.2 |
| A | 0.15 to 0.25 | 0.20 to 0.30 | 0.45 to 0.55 | 0.8 to 1.0 | 0.8 to 1.2 | 1.8 to 2.5 | 1.8 to 2.5 | 2.5 to 3.5 | |
| B | 0.15 to 0.20 | 0.20 to 0.30 | 0.40 to 0.50 | 0.6 to 0.8 | 0.8 to 1.2 | 1.0 to 1.5 | 1.0 to 1.5 | 1.5 to 1.8 | |
| C | 0.15 to 0.30 | 0.25 to 0.40 | 0.45 to 0.55 | 0.6 to 0.8 | 0.9 to 1.6 | 1.2 to 2.0 | 1.8 to 3.2 | 2.3 to 3.5 | |

Note: Recommended land size might be different according to the allowance of the size of the product.

● LWDC: Recommended land dimensions for reflow-soldering (unit: mm)

| Type | 105 | 107 | 212 | |
|------|--------------|-------------|------------|------|
| Size | L | 0.52 | 0.8 | 1.25 |
| | W | 1.0 | 1.6 | 2.0 |
| A | 0.18 to 0.22 | 0.25 to 0.3 | 0.5 to 0.7 | |
| B | 0.2 to 0.25 | 0.3 to 0.4 | 0.4 to 0.5 | |
| C | 0.9 to 1.1 | 1.5 to 1.7 | 1.9 to 2.1 | |

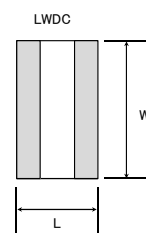

Technical considerations

* This catalog contains the typical specification only due to the limitation of space. When you consider the purchase of our products, please check our specification. For details of each product (characteristics graph, reliability information, precautions for use, and so on), see our Web site (<http://www.ty-top.com/>).

(2) Examples of good and bad solder application

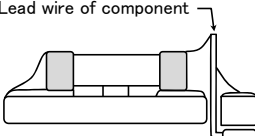
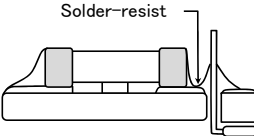
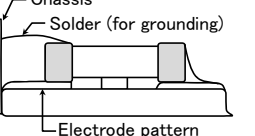
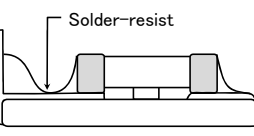
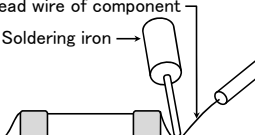
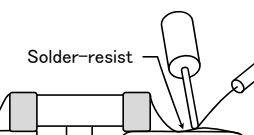
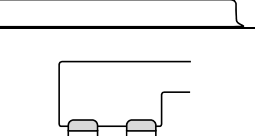
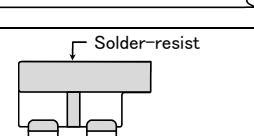
| Item | Not recommended | Recommended |
|---|---|---|
| Mixed mounting of SMD and leaded components |  |  |
| Component placement close to the chassis |  |  |
| Hand-soldering of leaded components near mounted components |  |  |
| Horizontal component placement |  |  |

◆ Pattern configurations (Capacitor layout on PCBs)

1-1. The following is examples of good and bad capacitor layouts ; capacitors shall be located to minimize any possible mechanical stresses from board warp or deflection.

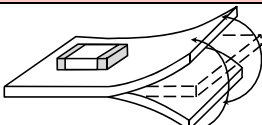
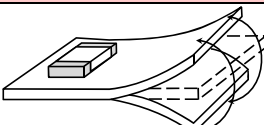
| Items | Not recommended | Recommended |
|---------------------|--|---|
| Deflection of board |  |  |

1-2. The amount of mechanical stresses given will vary depending on capacitor layout. Please refer to diagram below.

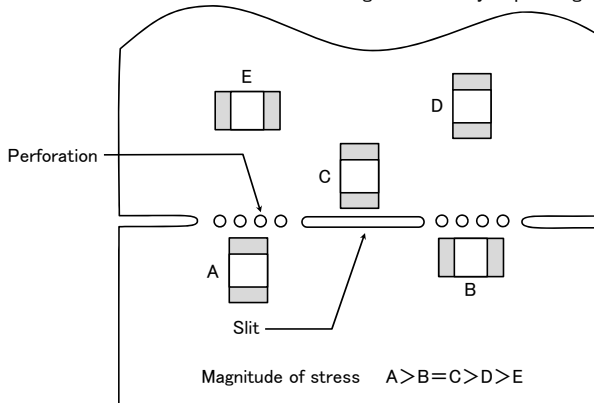

1-3. When PCB is split, the amount of mechanical stress on the capacitors can vary according to the method used. The following methods are listed in order from least stressful to most stressful: push-back, slit, V-grooving, and perforation. Thus, please consider the PCB, split methods as well as chip location.

3. Mounting

Precautions

◆ Adjustment of mounting machine

1. When capacitors are mounted on PCB, excessive impact load shall not be imposed on them.
2. Maintenance and inspection of mounting machines shall be conducted periodically.

◆ Selection of Adhesives

1. When chips are attached on PCBs with adhesives prior to soldering, it may cause capacitor characteristics degradation unless the following factors are appropriately checked : size of land patterns, type of adhesive, amount applied, hardening temperature and hardening period. Therefore, please contact us for further information.

◆Adjustment of mounting machine

- When the bottom dead center of a pick-up nozzle is too low, excessive force is imposed on capacitors and causes damages. To avoid this, the following points shall be considerable.
 - The bottom dead center of the pick-up nozzle shall be adjusted to the surface level of PCB without the board deflection.
 - The pressure of nozzle shall be adjusted between 1 and 3 N static loads.
 - To reduce the amount of deflection of the board caused by impact of the pick-up nozzle, supporting pins or back-up pins shall be used on the other side of the PCB. The following diagrams show some typical examples of good and bad pick-up nozzle placement:

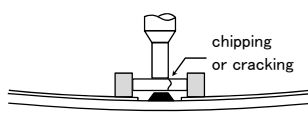
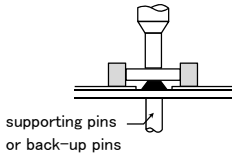
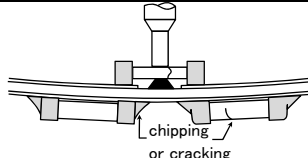
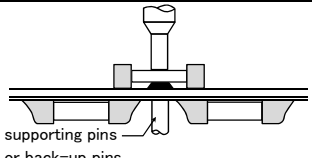
| Item | Improper method | Proper method |
|-----------------------|---|---|
| Single-sided mounting |  |  |
| Double-sided mounting |  |  |

Technical considerations

- As the alignment pin is worn out, adjustment of the nozzle height can cause chipping or cracking of capacitors because of mechanical impact on the capacitors. To avoid this, the monitoring of the width between the alignment pins in the stopped position, maintenance, check and replacement of the pin shall be conducted periodically.

◆Selection of Adhesives

Some adhesives may cause IR deterioration. The different shrinkage percentage of between the adhesive and the capacitors may result in stresses on the capacitors and lead to cracking. Moreover, too little or too much adhesive applied to the board may adversely affect components. Therefore, the following precautions shall be noted in the application of adhesives.

- Required adhesive characteristics
 - The adhesive shall be strong enough to hold parts on the board during the mounting & solder process.
 - The adhesive shall have sufficient strength at high temperatures.
 - The adhesive shall have good coating and thickness consistency.
 - The adhesive shall be used during its prescribed shelf life.
 - The adhesive shall harden rapidly.
 - The adhesive shall have corrosion resistance.
 - The adhesive shall have excellent insulation characteristics.
 - The adhesive shall have no emission of toxic gasses and no effect on the human body.
- The recommended amount of adhesives is as follows;

[Recommended condition]

| Figure | 212/316 case sizes as examples |
|--------|----------------------------------|
| a | 0.3mm min |
| b | 100 to 120 μ m |
| c | Adhesives shall not contact land |

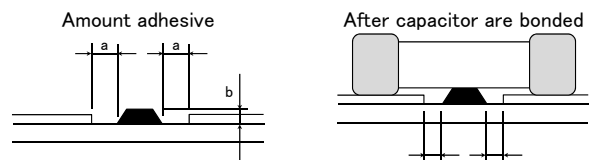

4. Soldering

◆Selection of Flux

- Since flux may have a significant effect on the performance of capacitors, it is necessary to verify the following conditions prior to use;
- Flux used shall be less than or equal to 0.1 wt% (in Cl equivalent) of halogenated content. Flux having a strong acidity content shall not be applied.
 - When shall capacitors are soldered on boards, the amount of flux applied shall be controlled at the optimum level.
 - When water-soluble flux is used, special care shall be taken to properly clean the boards.

Precautions

◆Soldering

Temperature, time, amount of solder, etc. shall be set in accordance with their recommended conditions.
 Sn-Zn solder paste can adversely affect MLOC reliability.
 Please contact us prior to usage of Sn-Zn solder.

Technical considerations

◆Selection of Flux

- When too much halogenated substance (Chlorine, etc.) content is used to activate flux, or highly acidic flux is used, it may lead to corrosion of terminal electrodes or degradation of insulation resistance on the surfaces of the capacitors.
- Flux is used to increase solderability in wave soldering. However if too much flux is applied, a large amount of flux gas may be emitted and may adversely affect the solderability. To minimize the amount of flux applied, it is recommended to use a flux-bubbling system.
- Since the residue of water-soluble flux is easily dissolved in moisture in the air, the residues on the surfaces of capacitors in high humidity conditions may cause a degradation of insulation resistance and reliability of the capacitors. Therefore, the cleaning methods and the capability of the machines used shall also be considered carefully when water-soluble flux is used.

* This catalog contains the typical specification only due to the limitation of space. When you consider the purchase of our products, please check our specification. For details of each product (characteristics graph, reliability information, precautions for use, and so on), see our Web site (<http://www.ty-top.com/>).

◆Soldering

- Ceramic chip capacitors are susceptible to thermal shock when exposed to rapid or concentrated heating or rapid cooling.
- Therefore, the soldering must be conducted with great care so as to prevent malfunction of the components due to excessive thermal shock.
- Preheating : Capacitors shall be preheated sufficiently, and the temperature difference between the capacitors and solder shall be within 130°C.
- Cooling : The temperature difference between the capacitors and cleaning process shall not be greater than 100°C.

[Reflow soldering]

【Recommended conditions for eutectic soldering】

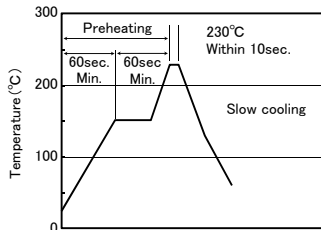

【Recommended condition for Pb-free soldering】

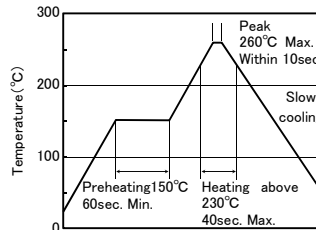

Caution

- ①The ideal condition is to have solder mass(fillet) controlled to 1/2 to 1/3 of the thickness of a capacitor.
- ②Because excessive dwell times can adversely affect solderability, soldering duration shall be kept as close to recommended times as possible.

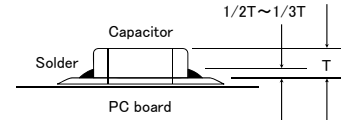

[Wave soldering]

【Recommended conditions for eutectic soldering】

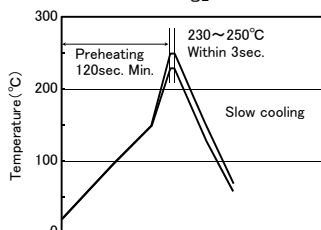

【Recommended condition for Pb-free soldering】

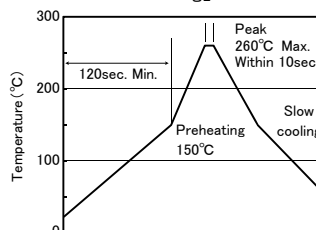

Caution

- ①Wave soldering must not be applied to capacitors designated as for reflow soldering only.

[Hand soldering]

【Recommended conditions for eutectic soldering】

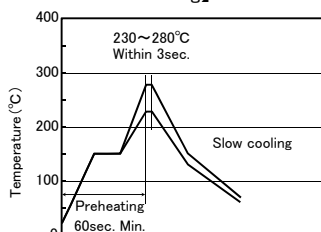

【Recommended condition for Pb-free soldering】

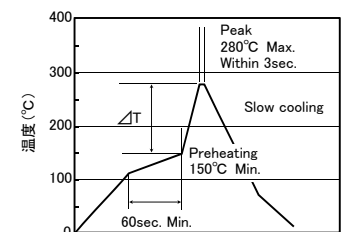
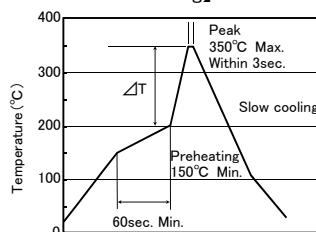

316type or less ΔT ≤ 150°C

325type or more ΔT ≤ 130°C

Caution

- ①Use a 50W soldering iron with a maximum tip diameter of 1.0 mm.
- ②The soldering iron shall not directly touch capacitors.

5. Cleaning

◆Cleaning conditions

1. When PCBs are cleaned after capacitors mounting, please select the appropriate cleaning solution in accordance with the intended use of the cleaning. (e.g. to remove soldering flux or other materials from the production process.)
2. Cleaning condition shall be determined after it is verified by using actual cleaning machine that the cleaning process does not affect capacitor's characteristics.

Technical considerations

1. The use of inappropriate cleaning solutions can cause foreign substances such as flux residue to adhere to capacitors or deteriorate their outer coating, resulting in a degradation of the capacitor's electrical properties (especially insulation resistance).
2. Inappropriate cleaning conditions(insufficient or excessive cleaning) may adversely affect the performance of the capacitors. In the case of ultrasonic cleaning, too much power output can cause excessive vibration of PCBs which may lead to the cracking of capacitors or the soldered portion, or decrease the terminal electrodes' strength. Therefore, the following conditions shall be carefully checked:
 Ultrasonic output : 20 W/l or less
 Ultrasonic frequency : 40 kHz or less
 Ultrasonic washing period : 5 min. or less

▶ This catalog contains the typical specification only due to the limitation of space. When you consider the purchase of our products, please check our specification. For details of each product (characteristics graph, reliability information, precautions for use, and so on), see our Web site (<http://www.ty-top.com/>).